



HOME DECOR

---

THE COLLECTION BOOK OF

# AUTHENTIC MODELS

DESIGNS WITH A STORY

---



## *Designs with a Story*

At Authentic Models, our décor tells the stories of lives lived, cherished memories, and passions pursued. Since our founding in Amsterdam in 1968, we have evolved from crafting specific home décor items to becoming a high-end furniture and decoration brand with a distinct European heritage. Our collections celebrate style, leisure, and adventure—expressing an outspoken spirit through unique furnishings and accessories that enrich spaces worldwide.

Every item in our collection is meticulously designed with an inspiring story behind it. Drawing on a legacy of craftsmanship and creativity, we aim to bring history to life in a way that feels both timeless and contemporary. Our designs are a celebration of the human spirit—capturing the elegance of the past while inviting a fresh perspective for the future. This fusion of inspiration and innovation allows us to create pieces that resonate deeply with our customers and adapt effortlessly to a range of personal styles.

Each piece we create is inspired by history, crafted with an adventurous spirit, and designed to captivate modern and traditional settings alike. Whether rooted in personal connections or chosen purely for aesthetic appeal, our creations offer a blend of character and quality that resonates with today's discerning customers. Going forward, we embark on a fresh journey of discovery, introducing intriguing new designs that celebrate the beauty of both tradition and innovation.



*Craftsmanship*

Design and materials provide the foundation for the beauty of our furniture and accessories, but it is the craftsmanship that transforms vision into reality. At the heart of every piece lies an unwavering commitment to detail, ensuring that each creation is a one-of-a-kind work of art. Our skilled artisans approach each project with mastery, precision, and care, turning raw materials into exceptional, distinctive products that transcend mere functionality.

We value the harmony between form and function, ensuring that every design not only serves a purpose but also delights the senses. By blending artistic vision with time-honored techniques, we craft objects that stand the test of time. Whether it's a sophisticated centerpiece or an everyday accessory, each piece carries an essence of originality and elegance that makes it unforgettable.

We believe in the philosophy that there are no mistakes in crafting—only opportunities to create something truly original. This dedication ensures that every item reflects the artisan's unique touch, making our products rich in character and individuality. Through elegantly handcrafted furniture, ornaments, and objects, we connect the essence of history with a daring contemporary twist. Let our collections inspire you to explore and celebrate style, adventure, and the art of living well.

*Table of Content*

<b>ELEMENTS OF THE SKIES</b>	<b>4</b>
CLASSIC BALLOONS	5 - 11
VELVET BALLOONS	12 - 15
LED ILLUMINATED BALLOONS	16 - 21
MOBILES	22 - 25
PLANE MODELS	26 - 29
DESKTOP MODELS	30 - 31
PROPELLERS	32 - 37
<b>CROSSING THE SEAS</b>	<b>38</b>
OARS	39
RUNABOUTS	40 - 43
SAILING SHIPS & STEAMERS	44 - 45
<b>WHEELS IN MOTION</b>	<b>46</b>
WOODEN CARS	47
ALUMINIUM CARS	48 - 49
<b>EXPLORING THE FRONTIER</b>	<b>50</b>
HONDIUS GLOBES	51
WEBER COSTELLO GLOBES	51
MERCATOR GLOBES	52
VAUGONDY GLOBES	53
ARMILLARIES & GLOBE STANDS	54 - 55
<b>EVERYDAY LIFE</b>	<b>56</b>
BALANCE TOYS	57 - 59
CLASSIC DECOR	60 - 67
GAMES	68 - 71
HOSPITALITY	72 - 75
WRITING SETS & ACCESSOIRES BOXES	76 - 79
<b>DETERMINE YOUR COURSE</b>	<b>80</b>
COMPASSES	81 - 83
GIFT BOXES	84
MAGNIFIERS	85 - 87
TELESCOPES	88 - 89
TIME COLLECTION	90 - 93
<b>HOW TO REACH US</b>	<b>95</b>



## ELEMENTS OF THE SKIES

From the serene grace of leisurely balloon rides to the high-speed efficiency of passenger jets and the formidable power of war planes, mankind's conquest of the skies stands as one of its greatest and most awe-inspiring achievements. The ability to soar above the clouds not only reshaped our world but also expanded the boundaries of human exploration, adventure, and defense.

Whether flight symbolizes the romantic allure of distant journeys and unexplored horizons or the critical role of defending a nation's freedom, the significance of aviation is undeniable. Authentic Models celebrates this triumph through an exquisite collection of handcrafted decoration pieces, each one a tribute to the many forms flight has taken over time.

These meticulously crafted models evoke the spirit of innovation, adventure, and history, capturing the essence of flight in its various forms—from the elegance of hot air balloons to the precision of military aircraft. Each piece not only tells a story of human ingenuity but also serves as a timeless reminder of our endless pursuit to conquer the skies.

## BALLOONS

Our balloons combine color, decor and themes, all-in-one. They're fascinating today as they were a century ago.

Since 1783, balloons have traveled the skies. Just imagine viewing the earth from above, free as a bird and holding onto a balloon basket.

Iconic and inspiring, these balloons will really fit into any home. Get ready to release the ballast and float away.



Gift Boxes AP160 / AP161 / AP163

## MEASUREMENTS

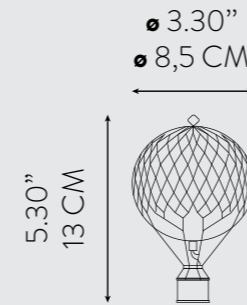

**AP160**  
Floating The Skies

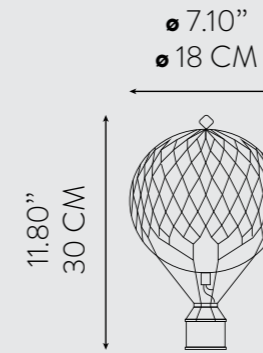

**AP161**  
Travels Light

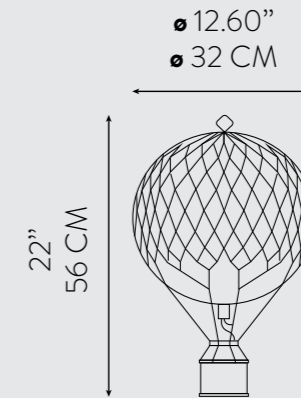

**AP163**  
Royal Aero

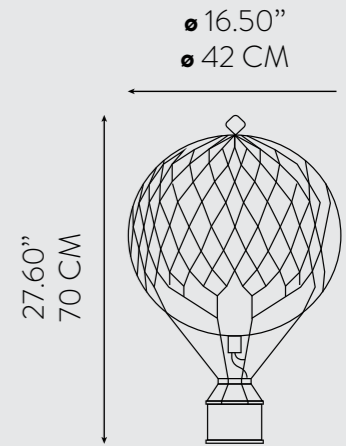

**AP168**  
Jules Verne





**BLACK**

Available as  
API60K / API61K / API63K  
See sizes at measurements page 5



**BLUE**

Available as  
API60D / API61D / API63D / API68D  
See sizes at measurements page 5



**BLUE STARS**

Available as  
API60BS / API61BS / API63BS  
See sizes at measurements page 5



**BLUE WHITE**

Available as  
API60BW / API61BW  
See sizes at measurements page 5



**DOUBLE RED**

Available as  
API60DR / API61DR / API63DR  
See sizes at measurements page 5



**DOUBLE YELLOW**

Available as  
API60DY / API61DY / API63DY  
See sizes at measurements page 5



**GOLD BLACK**

Available as  
API61GK  
See sizes at measurements page 5



**GOLD BLUE**

Available as  
API61GB  
See sizes at measurements page 5



**GOLD GREEN**

Available as  
API61GG  
See sizes at measurements page 5



**LAVENDER**

Available as  
API60L / API61L / API63L  
See sizes at measurements page 5



**LIGHT BLUE**

Available as  
API60BL / API61BL / API63BL  
See sizes at measurements page 5



**LIGHT PINK**

Available as  
API60PL / API61PL / API63PL  
See sizes at measurements page 5



**CHECK BLUE**

Available as  
API60CB / API61CB / API63CB  
See sizes at measurements page 5



**CHECK RED**

Available as  
API60CR / API61CR / API63CR  
See sizes at measurements page 5



**DOUBLE BLUE**

Available as  
API60DB / API61DB / API63DB  
See sizes at measurements page 5



**DOUBLE GREEN**

Available as  
API60DG / API61DG / API63DG  
See sizes at measurements page 5



**MINT**

Available as  
API60M / API61M / API63M / API68M  
See sizes at measurements page 5



**NAVY**

Available as  
API60N / API61N / API63N  
See sizes at measurements page 5



**ORANGE**

Available as  
API60O / API61O / API63O  
See sizes at measurements page 5



**PINK**

Available as  
API60P / API61P / API63P  
See sizes at measurements page 5



MAKE YOUR  
OWN DESIGN



**PURE BLACK**

Available as  
AP160PB / AP161PB / AP163PB  
See sizes at measurements page 5



**PURE WHITE**

Available as  
AP161PW  
See sizes at measurements page 5



**RAINBOW**

Available as  
AP160E / AP161E / AP163E / AP168E  
See sizes at measurements page 5



**RAINBOW PASTEL**

Available as  
AP160F / AP161F / AP163F / AP168F  
See sizes at measurements page 5



**SILVER PINK**

Available as  
AP161SP  
See sizes at measurements page 5



**SILVER RED**

Available as  
AP161SR  
See sizes at measurements page 5



**TRICOLORE**

Available as  
AP160I / AP161I  
See sizes at measurements page 5



**TRUE GREEN**

Available as  
AP160G / AP161G / AP163G / AP168G  
See sizes at measurements page 5



**RED HEARTS**

Available as  
AP160RH / AP161RH / AP163RH  
See sizes at measurements page 5



**RED WHITE**

Available as  
AP160RW / AP161RW  
See sizes at measurements page 5



**RED WHITE BLUE**

Available as  
AP160RWB / AP161RWB  
See sizes at measurements page 5



**SILVER BLACK**

Available as  
AP161SK  
See sizes at measurements page 5



**TRUE RED**

Available as  
AP160R / AP161R / AP163R / AP168R  
See sizes at measurements page 5



**TRUE YELLOW**

Available as  
AP160Y / AP161Y / AP163Y  
See sizes at measurements page 5



**USA**

Available as  
AP160US / AP161US / AP163US  
See sizes at measurements page 5



**WHITE IVORY**

Available as  
AP160W / AP161W / AP163W / AP168W  
See sizes at measurements page 5



**SILVER BLUE**

Available as  
AP160SB / AP161SB  
See sizes at measurements page 5



**SILVER GREEN**

Available as  
AP161SG  
See sizes at measurements page 5



**SILVER IVORY**

Available as  
AP161SI  
See sizes at measurements page 5



**SILVER NAVY**

Available as  
AP161SN  
See sizes at measurements page 5



**BALLOON STAND**

GL083  
11 x 11 x 17,5 cm  
4.3 x 4.3 x 6.9"  
\*Fits the AP160 Series





VELVET BALLOONS

Authentic Models, renowned for their exquisite craftsmanship and attention to detail, has once again captivated enthusiasts and collectors with their latest offering: the new velvet balloons. This collection exemplifies the brand's commitment to blending historical charm with contemporary elegance, transforming a classic toy into a sophisticated decorative piece.

The velvet balloons are a reimagined version of the beloved hot air balloon models that have been a staple of Authentic Models' repertoire. These new additions are distinguished by their luxurious velvet fabric, which envelops the balloon's spherical body. The rich texture of the velvet, available in a palette of vibrant and subdued hues, adds a tactile dimension that elevates the visual appeal of these pieces.

The versatility of the velvet balloons makes them a perfect addition to various interior styles. Whether adorning a sophisticated living room, a whimsical nursery, or an eclectic study, these pieces seamlessly integrate into any setting, adding a touch of nostalgia and elegance.



NEW ITEM

FLOATING THE SKIES, VELVET BLUE

API60VB  
8,5 x 8,5 x 13 cm  
3.3 x 3.3 x 5.3"



NEW ITEM

TRAVELS LIGHT, VELVET BLUE

API61VB  
18 x 18 x 30 cm  
7.1 x 7.1 x 11.8"



NEW ITEM

ROYAL AERO, VELVET BLUE

API63VB  
32 x 32 x 56 cm  
12.6 x 12.6 x 22"



NEW ITEM

FLOATING THE SKIES, VELVET RED

API60VR  
8,5 x 8,5 x 13 cm  
3.3 x 3.3 x 5.3"



NEW ITEM

TRAVELS LIGHT, VELVET RED

API61VR  
18 x 18 x 30 cm  
7.1 x 7.1 x 11.8"



NEW ITEM

ROYAL AERO, VELVET RED

API63VR  
32 x 32 x 56 cm  
12.6 x 12.6 x 22"



NEW ITEM

FLOATING THE SKIES, VELVET GREEN

API60VG  
8,5 x 8,5 x 13 cm  
3.3 x 3.3 x 5.3"



NEW ITEM

TRAVELS LIGHT, VELVET GREEN

API61VG  
18 x 18 x 30 cm  
7.1 x 7.1 x 11.8"



NEW ITEM

ROYAL AERO, VELVET GREEN

API63VG  
32 x 32 x 56 cm  
12.6 x 12.6 x 22"



## THE PERFECT HOLIDAY GIFT

Authentic Models has always been about more than just creating decorative items; they craft stories and experiences. The new velvet balloons are no exception. They invite onlookers to dream, to remember the thrill of adventure, and to appreciate the beauty of finely made objects. As with all of their products, these balloons are designed to inspire, delight, and transport individuals to a world where imagination takes flight.

The Velvet Balloons from Authentic Models are the quintessential holiday gift, blending elegance and whimsy in perfect harmony. These exquisitely crafted hot air balloon models are adorned with a luxurious velvet finish, offering a nostalgic charm that captures the spirit of adventure and the magic of the holiday season.

Each balloon is meticulously designed to serve as a stunning decorative piece, ideal for adding a touch of sophistication to any room. Whether as a centerpiece in a living room or a delightful addition to a child's bedroom, the Velvet Balloons are sure to enchant and inspire. Gift the Velvet Balloons this holiday and deliver a timeless treasure that brings joy and wonder to the hearts of your loved ones.





## LED ILLUMINATED BALLOONS

Our LED illuminated air balloons offer a captivating and enchanting display against the backdrop of the night sky. Combining the charm of traditional hot air ballooning with the innovation of modern LED technology, these creations are designed to mesmerize and inspire. As the sun sets and darkness falls, the soft glow of these balloons transforms any setting, creating an almost magical atmosphere as they light up the night.

Not only do they bring the nostalgia and elegance of classic hot air balloons, but they also highlight how human creativity can turn a simple concept into a breathtaking journey through the night sky. Whether used as decorative pieces or part of a special event, these illuminated balloons evoke a sense of wonder and adventure.

With remote control functionality, you can easily adjust the lighting to suit the mood or occasion, adding even more versatility to these stunning pieces. Each one serves as a reminder of how innovation can elevate tradition, blending past and present in a luminous spectacle.

**\*No batteries included**  
**\*Remote control included**



**TRAVELS LIGHT LED, BLUE**

**AP1611D**  
18 x 18 x 30 cm  
7.1 x 7.1 x 11.8"



**ROYAL AERO LED, BLUE**

**AP1631D**  
32 x 32 x 56 cm  
12.6 x 12.6 x 22"



**JULES VERNE LED, BLUE**

**AP1681D**  
42 x 42 x 70 cm  
16.5 x 16.5 x 27.6"



**TRAVELS LIGHT LED, RAINBOW**

**AP1611E**  
18 x 18 x 30 cm  
7.1 x 7.1 x 11.8"



**ROYAL AERO LED, RAINBOW**

**AP1631E**  
32 x 32 x 56 cm  
12.6 x 12.6 x 22"



**JULES VERNE LED, RAINBOW**

**AP1681E**  
42 x 42 x 70 cm  
16.5 x 16.5 x 27.6"



**TRAVELS LIGHT LED, TRUE RED**

**AP1611R**  
18 x 18 x 30 cm  
7.1 x 7.1 x 11.8"



**ROYAL AERO LED, TRUE RED**

**AP1631R**  
32 x 32 x 56 cm  
12.6 x 12.6 x 22"



**JULES VERNE LED, TRUE RED**

**AP1681R**  
42 x 42 x 70 cm  
16.5 x 16.5 x 27.6"



TRAVELS LIGHT LED, BLUE LIGHT

AP1611BL  
18 x 18 x 30 cm  
7.1 x 7.1 x 11.8"



ROYAL AERO LED, BLUE LIGHT

AP1631BL  
32 x 32 x 56 cm  
12.6 x 12.6 x 22"

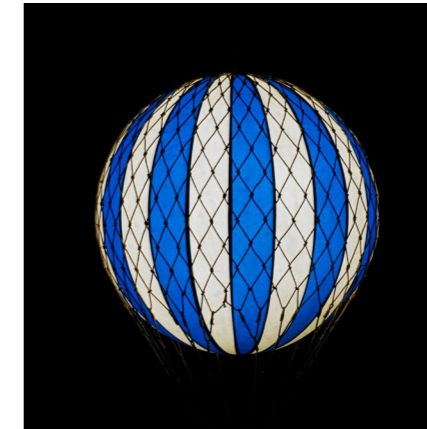

TRAVELS LIGHT LED, BLUE STARS

AP1611BS  
18 x 18 x 30 cm  
7.1 x 7.1 x 11.8"



ROYAL AERO LED, BLUE STARS

AP1631BS  
32 x 32 x 56 cm  
12.6 x 12.6 x 22"

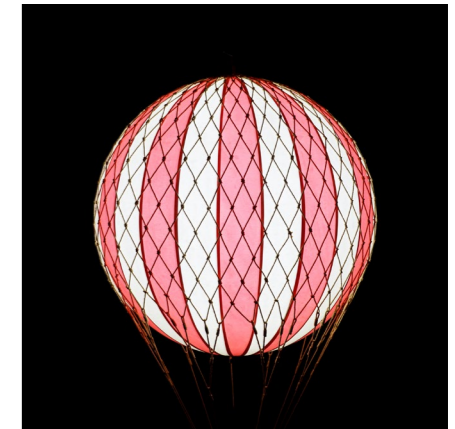
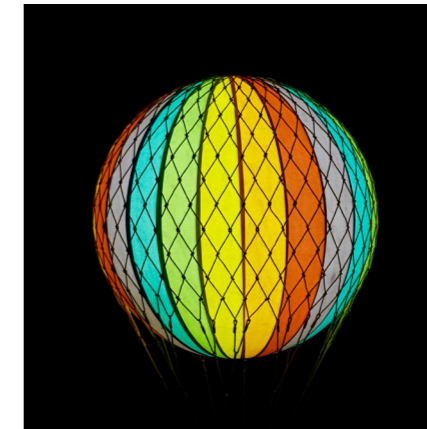

TRAVELS LIGHT LED, PINK LIGHT

AP1611PL  
18 x 18 x 30 cm  
7.1 x 7.1 x 11.8"



ROYAL AERO LED, PINK LIGHT

AP1631PL  
32 x 32 x 56 cm  
12.6 x 12.6 x 22"



# Elements of the Skies

LED ILLUMINATED BALLOONS



# Elements of the Skies

LED ILLUMINATED BALLOONS





**MOBILES**

Whether it's our balloons or planes, each piece is designed to stay in constant, graceful motion, thanks to the durable stainless steel wires and sturdy nylon lines that support them. These charming decorations add a touch of playful elegance to any space, making them a delightful addition to a child's room or a den. Not only are they fun to watch, but they are also easy to assemble, ensuring a hassle-free setup that will last for years to come.

Though miniature in size, every model is crafted with remarkable attention to detail, preserving the authenticity and accuracy that our brand is known for. Each piece captures the essence of its real-world counterpart, from the intricate features of an airplane to the timeless allure of a balloon drifting through the air.

Once hung, these beautifully crafted models create a captivating, dynamic display, offering a magnificent view that can be enjoyed from all angles. It's more than just décor—it's a celebration of graceful motion and timeless design, ready to inspire for generations.

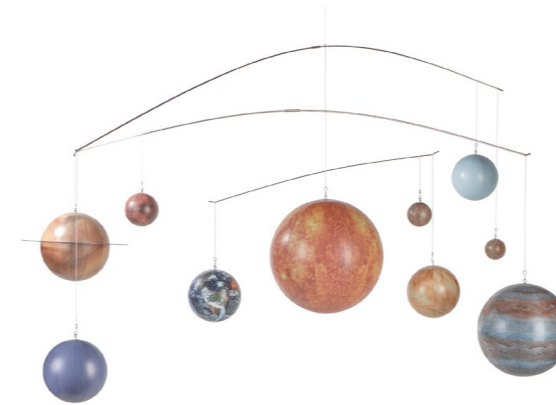

**MOBILE SOLAR SYSTEM**

**GL061**  
51 x 135 x 45 cm  
20.1 x 53.1 x 17.7"



**GLOBE MOBILE**

**GL060**  
108 x 18 x 90 cm  
42.5 x 7.1 x 35.4"



**A-CUP MOBILE**

**AS130**  
93 x 3,5 x 32 cm  
36.6 x 1.4 x 12.6"

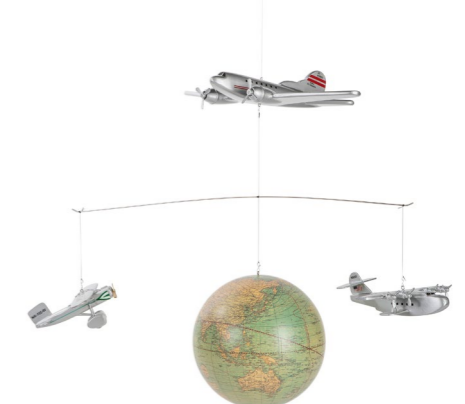

**AROUND THE WORLD MOBILE**

**AP124**  
34,5 x 66 x 40 cm  
13.6 x 26 x 15.7"



**FLIGHT MOBILE**

**AP120**  
66 x 58,5 x 30,5 cm  
26 x 23 x 12"



**GEE-BEE MOBILE**

**AP127**  
65 x 18 x 62 cm  
25.3 x 7 x 24.5"



**FLYING THE SKIES MOBILE,  
PRIMARY**

**AP128**  
85 x 8,8 x 66,5 cm  
33.5 x 3.5 x 26.3"



**FLYING THE SKIES MOBILE,  
PASTEL**

**AP129**  
85 x 8,8 x 66,5 cm  
33.5 x 3.5 x 26.3"



**FLYING THE SKIES MOBILE,  
PASTEL RAINBOW**

**AP132**  
85 x 8,8 x 66,5 cm  
33.5 x 3.5 x 26.3"



**FLYING THE SKIES MOBILE,  
BLACK & WHITE**

**AP133**  
85 x 8,8 x 66,5 cm  
33.5 x 3.5 x 26.3"



**FLYING THE SKIES MOBILE,  
RED HEARTS**

**AP134**  
85 x 8,8 x 66,5 cm  
33.5 x 3.5 x 26.3"



**FLYING THE SKIES MOBILE,  
BLUE STARS**

**AP135**  
85 x 8,8 x 66,5 cm  
33.5 x 3.5 x 26.3"



**FLYING THE SKIES MOBILE,  
US**

**AP136**  
85 x 8,8 x 66,5 cm  
33.5 x 3.5 x 26.3"



**FLYING THE SKIES MOBILE,  
PINK**

**AP137**  
85 x 8,8 x 66,5 cm  
33.5 x 3.5 x 26.3"



**FLYING THE SKIES MOBILE,  
BLUE**

**AP138**  
85 x 8,8 x 66,5 cm  
33.5 x 3.5 x 26.3"



PLANE MODELS

Legendary and full of nostalgia, our airplane models capture the spirit of aviation's most iconic machines. With aluminum, riveted propellers that evoke the classic roar of these aircraft, they bring back memories of a time when flight was both thrilling and dependable—noisy, yet safe and familiar. From the groundbreaking Ford Trimotor, a pioneer in commercial aviation, to the powerful and agile Spitfire, which dominated the skies during World War II, our collection is a tribute to aviation history. Each model is crafted with unbelievable attention to detail, meticulously recreating the unique features of these famous planes.

To complete the experience, every airplane comes with an aluminum stand, designed to showcase your model in style. Each stand includes a plaque, adding a touch of authenticity, and allowing you to proudly display your favorite aircraft in your home, office, or collection. Whether you're an aviation enthusiast or a collector, these models are the perfect way to celebrate the legends of the sky. So, are you ready for take-off? Explore the craftsmanship and history behind each model and let your collection soar.

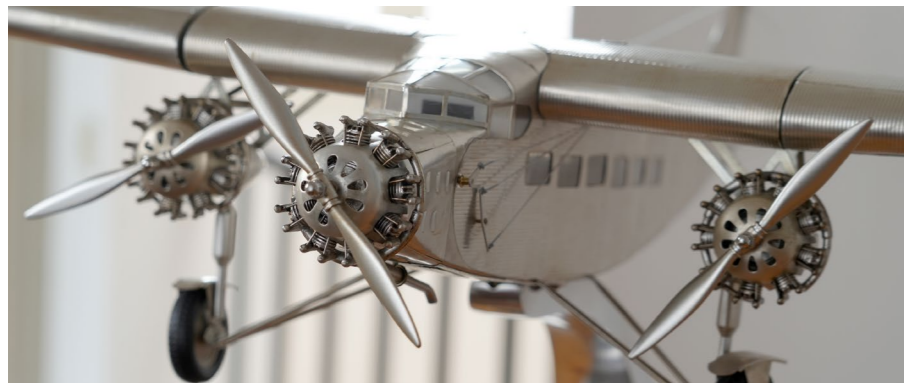

Between 1926 and 1933 only 199 Trimotors were built in Ford's own factory. Corrugated metal on great thick monoplane wings was a German development, used in Junker JU-52 planes that were flying the Berlin-Rome-London route. Trimotors were flown by airlines, oil companies and wealthy individuals. The Ford Trimotor and Junkers JU-52 were pioneering airplanes that led to generations of Douglas and Boeing fleets of aircraft, soon to criss-cross the world.



FORD TRIMOTOR

AP452  
103 x 72 x 43 cm  
40.6 x 28.3 x 16.9"



DAKOTA DC-3

AP455  
101 x 67 x 40 cm  
39.8 x 26.4 x 15.7"



The DC3 has earned the epithet "Workhorse of the Skies". Thousands were produced from the end of WWII into the 1950s by the Douglas Aircraft works. Military, civilian, government, private, you name it. Utterly reliable. Even now it's possible to find them flying from remote airports, landing on the tightest strips. Legendary and nostalgic. Aluminum, riveted propellers, noisy, but also safe and familiar.



SPITFIRE

AP456  
76 x 62 x 46 cm  
29.9 x 24.4 x 18.1"



The legendary Spitfire fighter was introduced in 1936 as a short-range, high-performance and single-seat aircraft. Beloved by pilots it still has an iconic status. Our model has unbelievable details like retractable main wheels, sliding cockpit window and functioning tail rudder. Shipped with an aluminum stand with plaque.



Sleek and powerful, Connie set a number of speed and distance records, despite experiencing frequent motor problems which led to them being jokingly called the most reliable three engine aircraft. The plane's elegant appearance was the result of no two bulkheads being the same shape. A design which has long since been superseded by cheaper, more pressure-change-resistant tube constructions.



CONNIE

AP458  
76 x 70 x 38 cm  
29.9 x 27.6 x 15"



CONCORDE

AP460  
40 x 86 x 48 cm  
15.7 x 33.9 x 18.9"



The Concorde was a supersonic passenger plane. Only twenty aircraft have been built, including four prototypes. The plane flew for the first time in 1969, it made its last flight on October 24, 2003.



TRIPLANE, TRANSPARENT

AP203T  
38,5 x 47 x 17 cm  
15,3 x 18,5 x 7,5"



SPAD, TRANSPARENT

AP413T  
60 x 76 x 23 cm  
23,6 x 29,9 x 9,1"



SOPWITH CAMEL, TRANSPARENT

AP502T  
102 x 150 x 45,5 cm  
40,2 x 59,1 x 17,9"



SOPWITH CAMEL, TRANSPARENT 250CM/98.4"

AP602T  
167 x 250 x 71 cm  
65,7 x 98,4 x 28"



LARGE ZEPPELING, TRANSPARENT

AP171T  
170 x 40 x 40 cm  
66,9 x 15,7 x 15,7"





## DESKTOP MODELS

Our aluminum desktop plane collection offers nostalgic, perfect replicas of early travel agent advertising signs, bringing a touch of aviation history to your workspace. These finely crafted pieces are far from ordinary, paying homage to some of the most iconic and historically significant planes ever to grace the skies. Each model is meticulously designed, making them not just decorative items but miniature tributes to the golden age of aviation.

The collection features classic planes in a size perfect for any desk, instantly elevating its aesthetic with their sleek, timeless design. From the breathtaking speed and innovation of the Concorde to the legendary combat prowess of the Spitfire, each model captures the spirit of aviation's most important milestones.

These miniatures are more than just replicas—they evoke the excitement and wonder of flight, making them the perfect addition for aviation enthusiasts and collectors alike. With every detail thoughtfully recreated, each plane will make your heart beat a little faster, transporting you back to an era when conquering the skies was the ultimate dream. Add one to your desk, and experience the thrill of aviation history right at your fingertips.



WWII MUSTANG DESK MODEL

AP098  
15 x 16 x 16 cm  
6 x 6.5 x 6.5"



SPITFIRE TRAVEL MODEL

AP099  
19 x 20 x 14,5 cm  
7.5 x 8 x 5.8"



DESKTOP DC-3

AP105  
27 x 36 x 17,5 cm  
10.6 x 14.2 x 6.9"



1930'S DC-3

AP110  
50 x 51 x 30 cm  
19.7 x 20.3 x 30"



CONCORDE

AP112  
46 x 17,5 x 21,3 cm  
18.1 x 6.9 x 8.3"



AUTOUR DE MONDE

AP103A  
21 x 26,5 x 18 cm  
8.3 x 10.4 x 7.1"



ON TOP OF THE WORLD

AP108  
22 x 26,5 x 31 cm  
8.7 x 10.4 x 12.2"



PROPELLERS

Few symbols capture the spirit of aviation history as powerfully as the propeller. In the past, old propellers were often taken home, fitted with clocks, and hung proudly as timeless decor. Inspired by this tradition, we've created faithful replicas of classic models, transforming them into attractive wall pieces which are easy to mount to any wall with our smart hanging system.

These propellers honor aviation's past while seamlessly fitting into modern interiors, bringing a vintage charm to any room. Each piece celebrates history while staying relevant to today's design, offering a stylish and meaningful tribute to the golden age of flight. Whether displayed in a home office, living room, or den, our propeller replicas bring a sense of adventure and historical significance to your space, blending craftsmanship with the timeless allure of aviation.

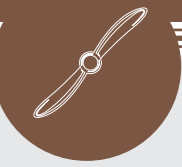
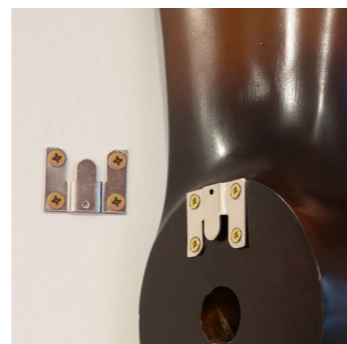

NEW ITEM

SOPWITH PARAGON SHINY, S

AP189  
120 x 12 x 5,8 cm  
47.3 x 4.8 x 2.3"



NEW ITEM

SOPWITH PARAGON SHINY, L

AP188  
186 x 15 x 9 cm  
73.2 x 5.9 x 3.5"



NEW ITEM

SOPWITH PARAGON MATTED, S

AP189M  
120 x 12 x 5,8 cm  
47.3 x 4.8 x 2.3"



NEW ITEM

SOPWITH PARAGON MATTED, L

AP188M  
186 x 15 x 9 cm  
73.2 x 5.9 x 3.5"



WWI VINTAGE STAR SMALL

AP177  
120 x 12 x 5,8 cm  
47.3 x 4.8 x 2.3"



WWI VINTAGE STAR LARGE

AP180  
186 x 15 x 9 cm  
73.2 x 5.9 x 3.5"

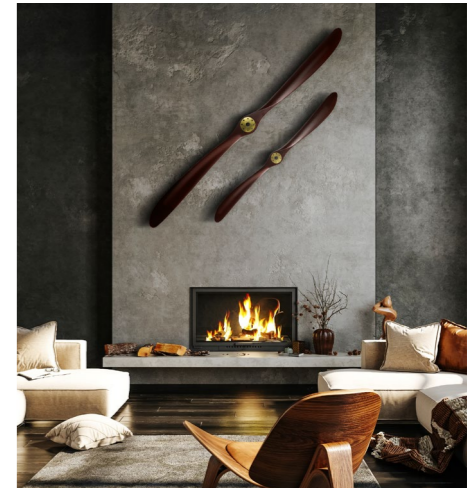

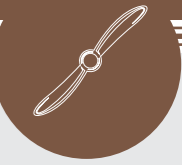

SOPWITH PROPELLER SMALL

AP149  
120 x 12 x 5,8 cm  
47.3 x 4.8 x 2.3"



SOPWITH PROPELLER LARGE

AP159  
186 x 15 x 9 cm  
73.2 x 5.9 x 3.5"



WWI WOOD PROPELLER SMALL

AP150  
120 x 12 x 5,8 cm  
47.3 x 4.8 x 2.3"



WWI WOOD PROPELLER LARGE

AP155  
186 x 15 x 9 cm  
73.2 x 5.9 x 3.5"

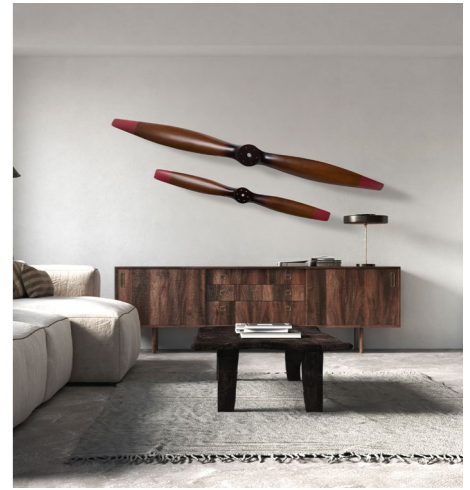

SOPWITH RED STRIPES SMALL

AP176  
120 x 12 x 5,8 cm  
47.3 x 4.8 x 2.3"



WWI VINTAGE PROPELLER SMALL

AP150F  
120 x 12 x 5,8 cm  
47.3 x 4.8 x 2.3"



WWI VINTAGE PROPELLER LARGE

AP155F  
186 x 15 x 9 cm  
73.2 x 5.9 x 3.5"

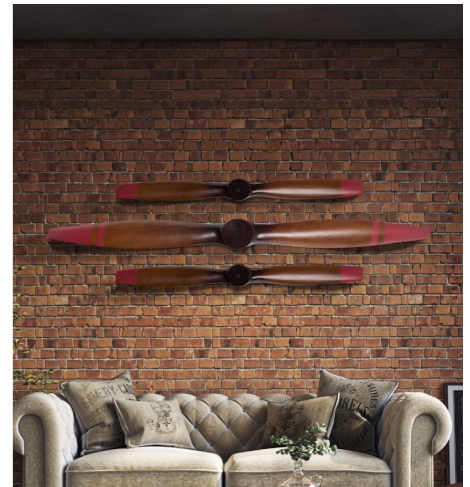

SOPWITH WWI SMALL

AP178  
120 x 12 x 5,8 cm  
47.3 x 4.8 x 2.3"



WWI BLUE TIP SMALL

AP186  
120 x 12 x 5,8 cm  
47.3 x 4.8 x 2.3"



WWI BLUE TIP LARGE

AP185  
186 x 15 x 9 cm  
73.2 x 5.9 x 3.5"

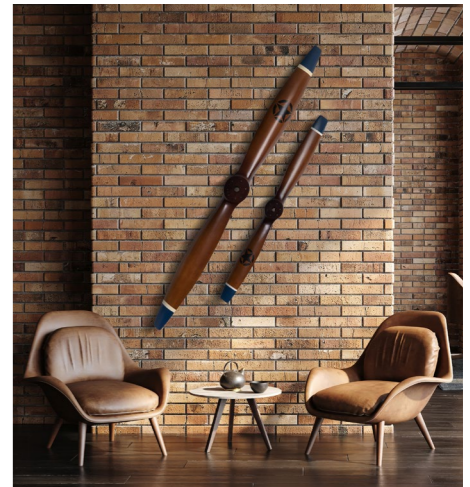

SOPWITH WWI LARGE

AP181  
186 x 15 x 9 cm  
73.2 x 5.9 x 3.5"



**BARNSTORMER #1**

**AP145**  
120 x 13,5 x 6,5 cm  
47.3 x 4 x 2.5"



**BARNSTORMER #2**

**AP146**  
120 x 13,5 x 6,5 cm  
47.3 x 4 x 2.5"



**BARNSTORMER #3**

**AP147**  
120 x 13,5 x 6,5 cm  
47.3 x 4 x 2.5"

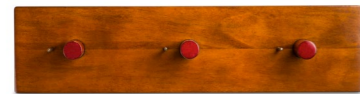

**BARNSTORMER RACK**

**AP148**  
55 x 14 x 9 cm  
21.8 x 5.5 x 3.5"



**SMALL PROPELLER, RED/GOLD**

**AP143**  
70 x 8 x 4,5 cm  
27.5 x 3.3 x 1.8"



**SMALL PROPELLER, BLACK/IVORY**

**AP144**  
70 x 8 x 4,5 cm  
27.5 x 3.3 x 1.8"

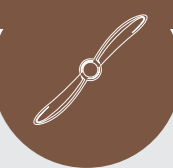

**VINTAGE FLIGHT LARGE**

**AP158**  
186 x 15 x 9 cm  
73.2 x 5.9 x 3.5"



**VINTAGE BLACK TIPS LARGE**

**AP182**  
186 x 15 x 9 cm  
73.2 x 5.9 x 3.5"



**VINTAGE FLIGHT BLACK LARGE**

**AP187**  
186 x 15 x 9 cm  
73.2 x 5.9 x 3.5"





## CROSSING THE SEAS

For centuries, people have taken to the water for countless reasons: exploration of uncharted lands, embarking on new lives, enjoying leisurely cruises, and testing their skills in sporting pursuits. Whether for adventure, luxury travel, or competition, these ships have shaped our relationship with the sea, conquering both tranquil waterways and wild ocean waves.

Authentic Models celebrates this spirit of adventure with a stunning collection of high-quality models that pay tribute to the history of crossing the seas. From the graceful lines of classic sailing ships to the sleek designs of luxurious steamers and runabouts, every piece is crafted with meticulous attention to detail, offering a true-to-history representation of these iconic vessels. Even decorative oars are transformed into unique, eye-catching pieces, blending maritime tradition with artistic flair.

By staying true to the historical significance of these vessels while incorporating original decorative twists, each model is not just a display of maritime history, but a celebration of the enduring human desire to conquer the water, explore the unknown, and indulge in the thrill of the journey.



### AQUARAMA, AQUA

AS180  
64 x 20 x 19 cm  
25.2 x 7.9 x 7.5"

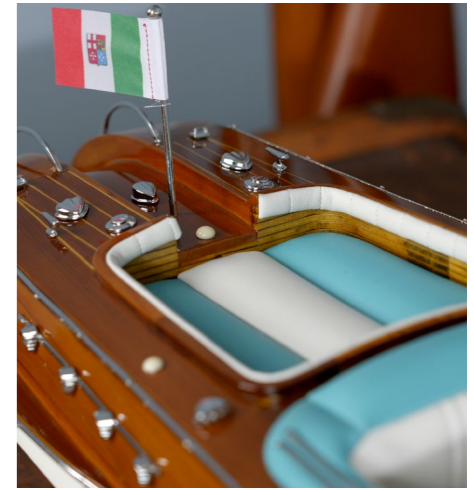

### AQUARAMA

AS182  
64 x 20 x 19 cm  
25.2 x 7.9 x 7.5"



### TRIPLE COCKPIT

AS183  
64 x 20 x 19 cm  
25.2 x 7.9 x 7.5"

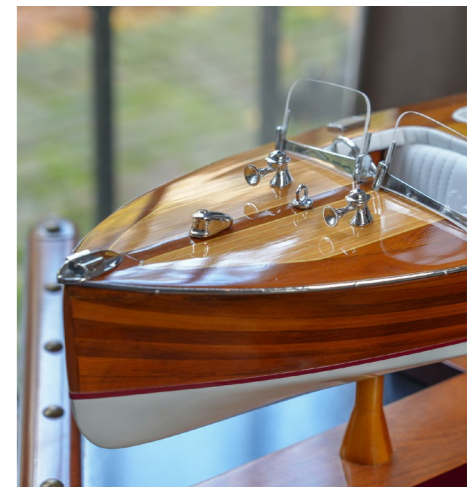



## SAILING SHIPS & STEAMERS

Our Authentic Models classics are must-have pieces for any maritime enthusiast or collector, offering timeless beauty and craftsmanship. Each model features a yacht-quality lacquer finish in a range of stunning colors, with wood hulls, intricately crafted cotton sails, and sturdy wood stands. These pieces are not just decorative but evoke the elegance and precision of classic seafaring vessels.

Among the collection is a tribute to one of history's greatest achievements—the largest man-made moving object ever to sail the seas. With interiors inspired by renowned architects, this model captures the grandeur and opulence that defined luxury ocean liners of the past. Our models recreate these iconic vessels with meticulous attention to detail, ensuring that every curve, line, and feature reflects the original design. These models are not just representations of ships; they symbolize the pinnacle of human endeavor and luxury, combining engineering brilliance with artistic beauty.



AMERICA'S CUP COLUMBIA 1901, SMALL

AS108F  
94 x 13 x 90 cm  
37 x 5.1 x 35.4"



CÔTRE, DARK GREEN

AS053  
67,3 x 12,7 x 78 cm  
26.5 x 5 x 30.7"



AMERICA'S CUP COLUMBIA, MEDIUM

AS076F  
114,5 x 18 x 118,5 cm  
45 x 7 x 46.7"



1930'S CLASSIC YACHT, SMALL

AS134  
54,5 x 12,8 x 59,8 cm  
21.5 x 5 x 23.5"



AMERICA'S CUP COLUMBIA, LARGE

AS075F  
173 x 23 x 166,5 cm  
68.1 x 9 x 65.6"



1930'S CLASSIC YACHT, LARGE

AS135  
90 x 15 x 90 cm  
35.4 x 5.9 x 35.4"



**J-YACHT 'RANGER' 1937**

**AS150**  
65 x 14,5 x 86,5 cm  
25,6 x 5,7 x 34"



**J-YACHT 'RAINBOW' 1932**

**AS152**  
65 x 14,5 x 86,5 cm  
25,6 x 5,7 x 34"



**AMERICA, SMALL**

**AS137**  
83,8 x 14 x 71,1 cm  
33 x 5,5 x 28"



**BLUENOSE II PAINTED**

**AS138**  
119,4 x 22,9 x 104 cm  
47 x 9 x 41"



**ENDEAVOUR L60, RED & WHITE**

**AS154**  
61 x 11,4 x 80 cm  
24 x 4,5 x 31,5"



**ENDEAVOUR L60, BLACK & WHITE**

**AS155**  
61 x 11,4 x 80 cm  
24 x 4,5 x 31,5"



**MINI POND YACHTS,  
SET OF 4**

**AS057A**  
51 x 8 x 50 cm  
20,1 x 3,1 x 19,7"



**USS CONSTELLATION**

**AS159**  
96,5 x 30,5 x 88 cm  
38 x 12 x 34,6"



**SUNSET SAILERS,  
SET OF 4**

**AS170**  
26,1 x 7,1 x 40,5 cm  
10,3 x 2,8 x 16,1"



**ENDEAVOUR CLASSIC WOOD**

**AS156**  
61 x 11,4 x 80 cm  
24 x 4,5 x 31,5"



**SHAMROCK YACHT WOOD**

**AS157**  
100,3 x 17,8 x 123,2 cm  
39,5 x 7 x 48,5"



OARS

For thousands of years, vessels were powered by sails or the strength of rowers and paddlers, with some ships using both oars and sails depending on wind conditions. This combination allowed for flexible navigation and played a key role in exploration and travel.

In rowing clubs worldwide, "trophy" oars are displayed as symbols of skill and endurance. Inspired by this tradition, our decorative oars are crafted from high-quality wood, just like the classics. They blend craftsmanship with elegance, making them timeless pieces that celebrate the legacy of nautical achievement and adventure.



ROYAL BARGE RACK 4

FE130  
69 x 7 x 9 cm  
27.2 x 2.8 x 3.6"



ROYAL BARGE OAR #1

FE123  
14 x 4,5 x 145 cm  
5.5 x 1.8 x 56.7"



ROYAL BARGE OAR #2

FE124  
14 x 4,5 x 145 cm  
5.5 x 1.8 x 56.7"



ROYAL BARGE OAR #3

FE125  
14 x 4,5 x 145 cm  
5.5 x 1.8 x 56.7"



ROYAL BARGE OAR #6

FE129  
14 x 4,5 x 145 cm  
5.5 x 1.8 x 56.7"



LIFEBOAT OAR

FE103  
184,3 x 14 x 4 cm  
72.5 x 5.5 x 1.6"



OXFORD VARSITY

FE104  
235 x 16,5 x 5 cm  
92.5 x 6.5 x 2"



TENDER OAR RED

FE105  
182 x 13,5 x 8 cm  
71.7 x 5.3 x 3.1"



TENDER OAR IVORY

FE106  
182 x 13,5 x 8 cm  
71.7 x 5.3 x 3.1"



TENDER OAR BLUE

FE107  
182 x 13,5 x 8 cm  
71.7 x 5.3 x 3.1"



## WHEELS IN MOTION

Our Authentic Models classics are must-have pieces for any maritime enthusiast or collector, offering timeless beauty and craftsmanship. Each model features a yacht-quality lacquer finish in a range of stunning colors, with wood hulls, intricately crafted cotton sails, and sturdy wood stands. These pieces are not just decorative but evoke the elegance and precision of classic seafaring vessels.

Among the collection is a tribute to one of history's greatest achievements—the largest man-made moving object ever to sail the seas. With interiors inspired by renowned architects, this model captures the grandeur and opulence that defined luxury ocean liners of the past. Our models recreate these iconic vessels with meticulous attention to detail, ensuring that every curve, line, and feature reflects the original design. These models are not just representations of ships; they symbolize the pinnacle of human endeavor and luxury, combining engineering brilliance with artistic beauty.



WOOD CAR MODEL, BLUE

AR063  
50 x 27 x 14 cm  
19.7 x 10.6 x 5.5"



WOOD CAR MODEL, SILVER

AR064  
50 x 27 x 14 cm  
19.7 x 10.6 x 5.5"

Expertly handcrafted from solid mahogany, this vintage-style racing car brings the charm of classic race tracks to life. Its flawless design and smooth finish highlight the craftsmanship, while the special Japanese metallic paint in three striking colors adds a luxurious touch. A must-have for car enthusiasts, this piece is both a tribute to racing history and a stylish addition to any collection.



WOOD CAR MODEL, RED

AR065  
50 x 27 x 14 cm  
19.7 x 10.6 x 5.5"





**BANTAM MIDGET, 19"**

**PC011**  
48 x 22 x 18 cm  
18.9 x 8.7 x 7.1"



**BANTAM MIDGET, RED**

**PC012**  
48 x 22 x 18 cm  
18.9 x 8.7 x 7.1"



**BANTAM MIDGET, GREEN**

**PC012G**  
48 x 22 x 18 cm  
18.9 x 8.7 x 7.1"



**INDIANAPOLIS, ALU / BLACK**

**PC010**  
31 x 14,6 x 9 cm  
12.3 x 5.8 x 3.5"



**INDIANAPOLIS, RED SEAT**

**PC010R**  
31 x 14,6 x 9 cm  
12.3 x 5.8 x 3.5"



**INDIANAPOLIS, WHITE / BLACK**

**PC010W**  
31 x 14,6 x 9 cm  
12.3 x 5.8 x 3.5"



**BB KORN**

**PC013**  
52,5 x 24,5 x 17,5 cm  
20.8 x 9.8 x 7"



**BB KORN, RED**

**PC013R**  
52,5 x 24,5 x 17,5 cm  
20.8 x 9.8 x 7"



**BB KORN, GREEN**

**PC013G**  
52,5 x 24,5 x 17,5 cm  
20.8 x 9.8 x 7"



**SILBERPFEIL**

**PC014**  
31 x 14,6 x 9 cm  
12.3 x 5.8 x 3.5"



**SILBERPFEIL BLACK, RED SEAT**

**PC014B**  
31 x 14,6 x 9 cm  
12.3 x 5.8 x 3.5"



**SILBERPFEIL, RED SEAT**

**PC014R**  
31 x 14,6 x 9 cm  
12.3 x 5.8 x 3.5"



**BLUE RACER**

**PC016**  
31 x 14,6 x 9 cm  
12.3 x 5.8 x 3.5"



**RED RACER**

**PC017**  
31 x 14,6 x 9 cm  
12.3 x 5.8 x 3.5"



**GIFT PACKAGE**

**FOR ALL CARS ON PAGE 49**  
31 x 14,6 x 9 cm  
12.3 x 5.8 x 3.5"



**EXPLORING THE FRONTIER**

A beautifully handcrafted globe is both a work of art and a historical reference, reflecting centuries of evolving knowledge. As explorers ventured into unknown lands and nations expanded their territories, globes evolved to capture these discoveries. Each version marks a chapter in the story of human exploration, serving as a testament to the growing understanding of our world. Authentic Models is a global leader in reproducing these antique globes, staying true to the traditional gravure printing technique that showcases the fine details and craftsmanship of the past.

Our collection represents five centuries of globe-making by some of history's most renowned cartographers. Each globe is mounted on tastefully designed stands that blend old-world charm with modern style. Whether you're a history enthusiast or simply appreciate fine craftsmanship, these globes serve as elegant and meaningful decor pieces that evoke a sense of wonder and nostalgia. Authentic Models is dedicated to preserving the artistry and historical significance of these timeless objects, making them perfect for any setting.



**HONDIUS GLOBES**

Legendary cartographer, Jodocus Hondius, worked in Amsterdam during the 1600s, then one of the world's commercial hubs. Spin the world and enjoy a touch of true history. Galleons sailing oceans to the farthest corners of the then known world.

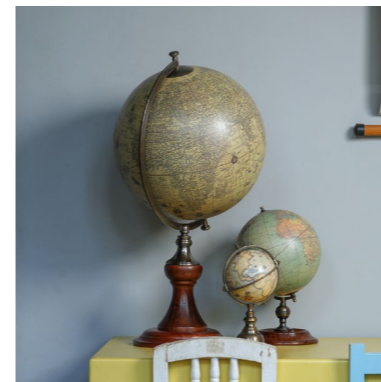

**WEBER COSTELLO GLOBES**

The world in 1921, roaring and still thriving. Somehow the French were able to create simple yet utterly scintillating globes and globe stands. Colored gores are applied to the globe core by hand with authentic construction and detail.



**VERSAILLES GLOBE**

**GL044**  
14 x 14 x 26,3 cm  
5.5 x 5.5 x 10.8"



**HONDIUS 1627, CLASSIC STAND**

**GL003D**  
34,5 x 34,5 x 61 cm  
13.6 x 13.6 x 24"



**1921 USA GLOBE, WEBER COSTELLO**

**GL026**  
18 x 18 x 30,5 cm  
12 x 12 x 7.1"



**RMN 19TH C. 19CM GLOBE**

**GL055**  
18 x 18 x 31 cm  
7 x 7 x 12"



**HONDIUS VINTAGE ROUND**

**GL064**  
36 x 32 x 44 cm  
14.2 x 12.6 x 17.3"



**WEBER COSTELLO GLOBE**

**GL036**  
32 x 32 x 50 cm  
12.6 x 12.6 x 19.7"



**WEBER COSTELLO 18CM**

**GL313**  
18 x 18 x 18 cm  
7 x 7 x 7"  
*\*Fits on Globe Stands*



**MERCATOR GLOBES**

An ode to the famous Dutch cartographer, Gerardus Mercator. As a scientific symbol, our table stands add a touch of distinction to home and office. Our globes really gives the feeling of living in the age of exploration.



**GLOBE BOOKENDS**

**GL009F**  
36 x 13 x 25 cm  
14.2 x 5.1 x 9.8"



**THE EARTH & THE HEAVENS**

**GL032**  
8,5 x 8,5 x 10,5 cm  
3.3 x 3.3 x 4.1"  
*\*Gift packaged*

**VAUGONDY GLOBES**

Gilles Robert de Vaugondy and his son, Didier Robert de Vaugondy, were the leading mapmakers in France during the 1700s. Didier was appointed geographer to Louis XV in 1760. Carrying science and history into the world of home décor. A unique combination of classic globe replica from historical cartography with spectacular decorative stands.



**VAUGONDY 1745, CLASSIC STAND**

**GL008D**  
34,5 x 34,5 x 61 cm  
13.6 x 13.6 x 24"



**VAUGONDY GLOBE 1745**

**GL021F**  
14 x 14 x 29,5 cm  
5.5 x 5.5 x 11.8"



**MERCATOR 1541, CLASSIC STAND**

**GL002D**  
34,5 x 34,5 x 61 cm  
13.6 x 13.6 x 24"



**MINI TERRESTRIAL GLOBE**

**GL015**  
12 x 12 x 22 cm  
4.7 x 4.7 x 8.7"



**STUDENT GLOBE**

**GL042**  
11 x 11 x 19,5 cm  
4.3 x 4.3 x 7.8"

**LIBRARY GLOBE**

**GL047**  
48 x 48 x 96 cm  
19 x 19 x 37.8"



**VAUGONDY 1745, NOIR**

**GL041**  
32 x 32 x 50 cm  
12.6 x 12.6 x 19.7"



**1920S GLOBE 32 CM**

**GL043**  
32 x 32 x 50 cm  
12.6 x 12.6 x 19.7"



**NAVIGATOR'S TERRESTRIAL GLOBE**

**GL023F**  
26,5 x 26,5 x 29,8 cm  
10.4 x 10.4 x 11.8"



**NAVIGATOR'S TERRESTRIAL GLOBE, LARGE**

**GL025**  
44,5 x 44,5 x 51 cm  
17.5 x 17.5 x 20"



**TERRESTRIAL GLOBE WITH COMPASS**

**GL019**  
14,5 x 14,5 x 21 cm  
5.7 x 5.7 x 8.3"



**THE AGE OF EXPLORATION**

**GL031**  
8,5 x 8,5 x 10,5 cm  
3.3 x 3.3 x 4.1"  
*\*Gift packaged*



**1745 VAUGONDY GLOBE IN A BOX, SMALL**

**GL027**  
8,5 x 8,5 x 9 cm  
3.5 x 3.5 x 3.3"  
*\*Gift packaged*



**VAUGONDY HANGING S**

**GL074**  
18 x 18 x 18 cm  
7 x 7 x 7"  
Including 3 hooks



**TRIANON GLOBE**

**GL045**  
14 x 14 x 27,5 cm  
5.5 x 5.5 x 10.8"



**VAUGONDY SPHERE  
COLOR, 14 CM**

GL213  
14 x 14 x 14 cm  
5.5 x 5.5 x 5.5"  
*\*Fits on Globe Stands*



**WEBER  
COSTELLO 18CM**

GL313  
18 x 18 x 18 cm  
7 x 7 x 7"  
*\*Fits on Globe Stands*



**VAUGONDY SPHERE  
BLACK, 14CM**

GL211  
14 x 14 x 14 cm  
5.5 x 5.5 x 5.5"  
*\*Fits on Globe Stands*



**VAUGONDY  
BLACK, 18CM**

GL311  
18 x 18 x 18 cm  
7 x 7 x 7"  
*\*Fits on Globe Stands*



**VAUGONDY SPHERE  
IVORY, 14CM**

GL212  
14 x 14 x 14 cm  
5.5 x 5.5 x 5.5"  
*\*Fits on Globe Stands*



**VAUGONDY  
IVORY, 18CM**

GL312  
18 x 18 x 18 cm  
7 x 7 x 7"  
*\*Fits on Globe Stands*



**ALUMINIUM  
GLOBE BASE**

GL200A  
11 x 11 x 1,5 cm  
4.3 x 4.3 x 0.6"  
*\*Globe not included*



**DUOTONE BRONZE  
GLOBE BASE**

GL200B  
11 x 11 x 1,5 cm  
4.3 x 4.3 x 0.6"  
*\*Globe not included*



**WOODEN GLOBE  
BASE, SMALL**

GL079  
12 x 12 x 12 cm  
4.7 x 4.7 x 4.7"  
*\*Globe not included*



**WOODEN GLOBE  
BASE, MEDIUM**

GL080  
8 x 8 x 16 cm  
3.1 x 3.1 x 6.3"  
*\*Globe not included*



**WOODEN GLOBE  
BASE, LARGE**

GL081  
9,5 x 9,5 x 20 cm  
3.7 x 3.7 x 7.9"  
*\*Globe not included*



**ARMILLARIES**

Our armillary sphere are models of objects in the sky, consisting of a beautiful framework full of rings. With the Earth or the sun in the center, and lines representing the celestial longitude and latitude with other astronomically features. We recreated our armillary spheres so you can map the constelations like the ancient greeks or chineze.



**18TH C. ATLAS ARMILLARY**

GL051  
25,5 x 25,5 x 56 cm  
10 x 10 x 22"



**BRONZE ARMILLARY DIAL**

GL052  
18,5 x 18,5 x 36,5 cm  
7.3 x 7.3 x 14.4"



**ARROW ARMILLARY**

GL082  
28 x 20,5 x 35,5 cm  
11 x 8.1 x 14"



EVERYDAY LIFE

In a world where everything moves at lightning speed, there is something profoundly grounding about embracing hobbies, interests, recreational activities, and daily routines that hark back to simpler times. These pursuits offer a sense of connection to the past, a way to slow down and appreciate the beauty of craftsmanship, dedication, and tradition. They remind us of a time when people took pride in creating objects that were meant to last—when the journey of making was as rewarding as the final product itself.

Authentic Models celebrates this enduring spirit by creating an exquisite range of functional and decorative items that capture the passion, pride, and craftsmanship of yesteryear. Each piece is thoughtfully designed to merge historic charm with a touch of contemporary flair, resulting in original objects that are both timeless and distinctive. Using only the highest quality materials, our products are crafted to reflect the meticulous attention to detail and artistry of the past, while fitting seamlessly into modern-day spaces. With Authentic Models, you can bring a piece of history into your home, adding a unique and tasteful element that honors the beauty of tradition.



SALTY DOG

TM036  
45 x 24 x 11 cm  
17.7 x 9.5 x 4.3"  
\*Gift packaged



PIRATE

TM040  
45 x 24 x 11 cm  
17.7 x 9.5 x 4.3"  
\*Gift packaged



RIDING THE WAVES

TM044  
45 x 24 x 11 cm  
17.7 x 9.5 x 4.3"  
\*Gift packaged



FISHERMAN

TM047  
45 x 24 x 11 cm  
17.7 x 9.5 x 4.3"  
\*Gift packaged



FLY FISHERMAN

TM041  
45 x 24 x 11 cm  
17.7 x 9.5 x 4.3"  
\*Gift packaged



WHALE

TM048  
45 x 24 x 11 cm  
17.7 x 9.5 x 4.3"  
\*Gift packaged



FLYING ACE

TM074  
45 x 24 x 11 cm  
17.7 x 9.5 x 4.3"



RED BARON

TM082  
45 x 24 x 11 cm  
17.7 x 9.5 x 4.3"



HELMSMAN

TM050  
45 x 24 x 11 cm  
17.7 x 9.5 x 4.3"  
\*Gift packaged



PRINCESS

TM110  
45 x 24 x 11 cm  
17.7 x 9.5 x 4.3"  
\*Gift packaged



KNIGHT

TM111  
45 x 24 x 11 cm  
17.7 x 9.5 x 4.3"  
\*Gift packaged

NEW ITEM



SANTA'S SLEIGH

TM053  
45 x 24 x 11 cm  
17.7 x 9.5 x 4.3"  
\*Gift packaged



KING

TM113  
45 x 24 x 11 cm  
17.7 x 9.5 x 4.3"  
\*Gift packaged



QUEEN

TM114  
45 x 24 x 11 cm  
17.7 x 9.5 x 4.3"  
\*Gift packaged

NEW ITEM



SKIING SANTA

TM066  
45 x 24 x 11 cm  
17.7 x 9.5 x 4.3"  
\*Gift packaged

NEW ITEM



WITCH

TM142  
45 x 24 x 11 cm  
17.7 x 9.5 x 4.3"  
\*Gift packaged

NEW ITEM



PUMPKIN

TM143  
45 x 24 x 11 cm  
17.7 x 9.5 x 4.3"  
\*Gift packaged

NEW ITEM



GHOST

TM144  
45 x 24 x 11 cm  
17.7 x 9.5 x 4.3"  
\*Gift packaged





TABLE  
ROCKING HORSE

RH002  
74 x 15 x 52 cm  
29.1 x 5.9 x 20.5"  
\*Not a toy



VICTORIAN  
ROCKING HORSE

RH006  
142,5 x 46,5 x 120,5 cm  
56 x 18.3 x 47.5"  
\*Not a toy



ROCKING HORSE,  
WESTERN SADDLE

RH006W  
142,5 x 46,5 x 120,5 cm  
56 x 18.3 x 47.5"  
\*Not a toy



STANDING STICK

MF192  
84 x 40,5 x 14 cm  
33 x 15.9 x 5.5"



GOLF CLUB  
COAT RACK, BROWN

TH007  
12 x 40,5 x 15,5 cm  
4.7 x 15.9 x 6.1"



GOLF CLUB  
COAT RACK, BLACK

TH007B  
12 x 40,5 x 15,5 cm  
4.7 x 15.9 x 6.1"



ARTIST HAND

MG001F  
10 x 10 x 25 cm  
4 x 4 x 9.8"



ARTIST HORSE

MG003F  
22,5 x 6 x 23 cm  
8.9 x 2.4 x 9"



ARTIST HORSE, LARGE

MG006F  
37 x 8,5 x 34 cm  
14.6 x 3.4 x 13.4"



SHOE HORN GOLF

AC141  
6 x 4,1 x 57,6 cm  
2.4 x 1.6 x 22.7"



SHOE HORN SEAHORSE

AC142  
0,5 x 4 x 59 cm  
0.2 x 1.6 x 23.2"



CAPTAIN'S  
WALKING STICK

WS002  
3,5 x 3,5 x 92 cm  
1.4 x 1.4 x 36.2"



TELESCOPE  
WALKING STICK

WS005  
5 x 5 x 98 cm  
2 x 2 x 38.5"



TIME  
COMPANION

WS006  
6,5 x 6,5 x 88 cm  
2.6 x 2.6 x 34.6"



PHRENOLOGY HEAD

MG020  
14 x 16,5 x 29 cm  
5,5 x 6,5 x 11,4"



PHRENOLOGY HEAD SMALL

MG024  
11 x 9,5 x 21 cm  
4,4 x 3,8 x 8,3"



PAPERWEIGHT CLASSIC

PW006  
14 x 14 x 5 cm  
5,5 x 5,5 x 2"  
*\*Stickers included*



CABIN PORTHOLE MIRROR, MEDIUM

AC188A  
38 x 38 x 7 cm  
15 x 15 x 2,8"



LOUNGE PORTHOLE MIRROR, LARGE

AC189A  
51 x 51 x 7 cm  
20,1 x 20,1 x 2,8"



ART DECO MIRROR

AC195  
49,5 x 2,5 x 70 cm  
19,5 x 1 x 27,6"



HUDSON TRAIN

AM032  
58 x 9 x 21 cm  
22,8 x 3,5 x 8,3"



CAPE HORN ANCHOR

AC006  
15,5 x 11 x 9,5 cm  
6,1 x 4,3 x 3,7"



BOSUN'S WISTLE

BW001  
5 x 2 x 2 cm  
2 x 0,8 x 0,8"  
*\*Gift packaged*



VICTORIAN WHISTLE

BW002  
5 x 2 x 2 cm  
2 x 0,8 x 0,8"  
*\*Gift packaged*



WHITE STAR CALL

BW003  
5 x 2 x 2 cm  
2 x 0,8 x 0,8"  
*\*Gift packaged*



DOORSTOPPER COTTON

HD001  
20 x 20 x 22 cm  
7,9 x 7,9 x 8,7"



DOORSTOPPER SISAL

HD002  
20 x 20 x 22 cm  
7,9 x 7,9 x 8,7"



DOORSTOPPER MULTI

HD006  
34 x 15 x 15 cm  
13,4 x 5,9 x 5,9"



DOORSTOPPER BLUE

HD007  
34 x 15 x 15 cm  
13,4 x 5,9 x 5,9"

NEW ITEM

NEW ITEM





NEW ITEM

**BUGLE**

**MC155**  
14 x 12,3 x 32,2 cm  
5.5 x 4.8 x 12.7"



NEW ITEM

**CLARINET**

**MC158**  
66 x 14,5 x 14,5 cm  
26 x 5.7 x 5.7"



NEW ITEM

**TRUMPET, GOLD**

**MC156G**  
17 x 14,5 x 53,6 cm  
6.7 x 5.7 x 21.1"



NEW ITEM

**TRUMPET, SILVER**

**MC156S**  
17 x 14,5 x 53,6 cm  
6.7 x 5.7 x 21.1"



NEW ITEM

**MINI VIOLIN  
IN FRAME**

**MC159**  
5 x 16,2 x 25,1 cm  
2 x 6.4 x 9.9"



NEW ITEM

**MINI VIOLIN  
W/ STAND**

**MC160**  
3,8 x 8,4 x 3,2 cm  
1.5 x 3.3 x 1.3"



NEW ITEM

**MINI CELLO  
W/ STAND**

**MC161**  
5 x 12 x 3,6 cm  
2 x 4.7 x 1.3"



NEW ITEM

**MINI DOUBLE BASS  
W/ STAND**

**MC162**  
7,8 x 8,5 x 5,6 cm  
3 x 3.3 x 2.2"



NEW ITEM

**MINI TRUMPET**

**MC163**  
5,2 x 14 x 4,7 cm  
2 x 5.5 x 1.8"



NEW ITEM

**MINI TROMBONE**

**MC164**  
5,4 x 17 x 4,6 cm  
2.1 x 6.7 x 1.8"



NEW ITEM

**MINI CLARINET**

**MC165**  
4,4 x 19,2 x 3,6 cm  
1.7 x 7.6 x 1.4"



NEW ITEM

**MINI ALTO SAX**

**MC166**  
7 x 18,1 x 4,4 cm  
2.8 x 7.1 x 1.7"



**MONKEY'S FIST/SHACKLE**

**FW003**  
12 x 3 x 4 cm  
4.7 x 1.2 x 1.6"



**KEYCHAIN PROPELLOR**

**KC003**  
3,7 x 8,9 x 7,7 cm  
1,4 x 3,5 x 3"



**KEYCHAIN ANCHOR**

**KC008**  
2,3 x 5,5 x 13,1 cm  
0,9 x 2,2 x 5,2"



**KEYCHAIN BALL**

**KC011**  
10,8 x 3,3 x 3,3 cm  
4,3 x 1,3 x 1,3"



**KEYCHAIN BLOCK**

**KC014**  
1,4 x 2,1 x 11,4 cm  
0,5 x 0,8 x 4,7"



**KEYCHAIN LAMP RED**

**KC005A**  
10,6 x 2,2 x 2,2 cm  
4,2 x 0,9 x 0,9"



**KEYCHAIN LAMP WHITE**

**KC005B**  
10,6 x 2,2 x 2,2 cm  
4,2 x 0,9 x 0,9"



**KEYCHAIN BLOCK TRIPLE**

**KC014C**  
2,1 x 2,5 x 11,1 cm  
0,8 x 1 x 4,4"



**KEYCHAIN BELL**

**KC015**  
11,8 x 2,4 x 2,4 cm  
4,6 x 1 x 1"



**KEYCHAIN STEAM WHISTLE**

**KC019**  
14,7 x 1,6 x 1,6 cm  
5,8 x 0,6 x 0,6"



**KEYCHAIN BELL 1ST CLASS**

**KC006**  
11,6 x 2,5 x 2,5 cm  
4,6 x 1 x 1"



**KEYCHAIN WHISTLE**

**KC007**  
12,3 x 0,8 x 0,8 cm  
4,8 x 0,3 x 0,3"



**KEYCHAIN COMPASS**

**KC072B**  
1,3 x 3,7 x 11 cm  
0,5 x 1,4 x 4,3"



**KEYCHAIN SAND TIMER**

**KC080**  
11,7 x 0,9 x 0,9 cm  
4,6 x 0,3 x 0,3"



**KEYCHAIN HELMET + COMPASS**

**KC082**  
9 x 2,2 x 2,2 cm  
3,5 x 0,8 x 0,8"



**CLASSIC STAUNTON CHESS SET**

**GR021**  
King measures: 3,4 x 3,4 x 8 cm  
1,3 x 1,3 x 3,2"  
\*Gift packaged  
\* Excluding chess board  
Match with the GR034 / GR036 / MF164



**MASTER STAUNTON CHESS SET**

**GR027**  
King measures: 4,5 x 4,5 x 12 cm  
1,7 x 1,7 x 4,5"  
\* Excluding chess board  
Match with the MF020 / MF034



**CHESS SET METAL**

**GR033**  
King measures: 3 x 3 x 9,5 cm  
1,2 x 1,2 x 3,5"  
\*Gift packaged  
\* Excluding chess board  
Match with the GR034 / GR036 / MF164



**DICE BOX WITH 5 DICES, BRASS**

**GR030**  
6,5 x 6,5 x 6,5 cm  
2,6 x 2,6 x 2,6"



**DICE BOX WITH 5 DICES, SILVER**

**GR031**  
6,5 x 6,5 x 6,5 cm  
2,6 x 2,6 x 2,6"



**DICE BOX WITH 5 DICES, BLACK**

**GR031B**  
6,5 x 6,5 x 6,5 cm  
2,6 x 2,6 x 2,6"



**CHECKERS SET**

**GR035**  
3,3 x 3,3 x 0,9 cm  
1,3 x 1,3 x 0,3"  
\*Gift packaged  
\* Excluding checkers board  
Match with the GR034 / GR036



**CHECKERS SET METAL**

**GR037**  
3,3 x 3,3 x 0,9 cm  
1,3 x 1,3 x 0,3"  
\*Gift packaged  
\* Excluding checkers board  
Match with the GR034 / GR036

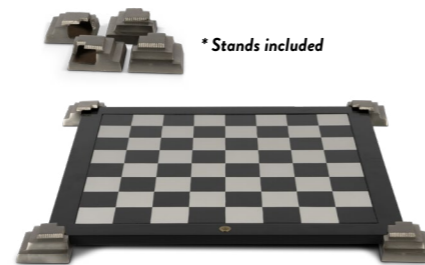

**2-SIDED GAME BOARD BLACK**

**GR036**  
47 x 47 x 4 cm  
18,5 x 18,5 x 1,6"  
\*Chess & Checkers  
\* Stands included



**DICE TRAY**

**GR039**  
31 x 31 x 5 cm  
12,2 x 12,2 x 2"



**NO QUARTER**

**GR010**  
35 x 35 x 9 cm  
13,8 x 13,8 x 3,5"  
\*Gift packaged



**CHESS & BACKGAMMON IN CASE**

**GR038**  
37,5 x 24 x 9,5 cm  
14,8 x 9,4 x 3,7"





**DUTCH RENAISSANCE DOMINO GAME**

**GR001F**  
19,5 x 18,5 x 3,2 cm  
7,7 x 7,3 x 1,3"  
\*Gift packaged



**SOLITAIRE GAME 20MM**

**GR005F**  
25 x 25 x 3,5 cm  
9,8 x 9,8 x 1,4"  
\*Gift packaged



**SOLITAIRE DI VENEZIA, 25MM MARBLES**

**GR007**  
30 x 30 x 3 cm  
11,8 x 11,8 x 1,2"  
\*Gift packaged



**SEMI-PRECIOUS SOLITAIRE GAME, 30MM**

**GR022**  
35 x 35 x 9 cm  
13,8 x 13,8 x 3,5"



**COMPASS JOURNAL**

**MS010A**  
13 x 20,5 x 1,8 cm  
5,1 x 8,1 x 0,7"



**MARINER'S COMPASS**

**MS013A**  
10,4 x 11 x 1,8 cm  
4,1 x 4,3 x 0,7"



**MARITIME POCKET SUNDIAL**

**MS019A**  
9,5 x 10 x 3 cm  
3,9 x 2,9 x 1,2"



**TRAVELER'S WORLD GLOBE IN A BOX**

**MS021A**  
10 x 10 x 8,8 cm  
4 x 4 x 3,5"



**BOAT IN A BOTTLE KIT**

**MS022A**  
14,5 x 12 x 7 cm  
5,7 x 4,5 x 2,8"



**IT'S A TOSS UP**

**MS054A**  
14 x 14 x 6 cm  
5,5 x 5,5 x 2,4"



**LEARN THE ROBES**

**MS071A**  
13,8 x 11,8 x 2,5 cm  
5,4 x 4,6 x 1"



**SEEING STARS, KALEIDOSCOPE KIT**

**MS073A**  
21,5 x 6,5 x 6,5 cm  
8,6 x 2,6 x 2,6"



WINERY BOX, COGNAC

BA022  
43 x 22 x 23 cm  
16.9 x 8.7 x 9.1"



WINERY BOX, BLACK

BA022B  
43 x 22 x 23 cm  
16.9 x 8.7 x 9.1"



1  
CAVIER BOWL

BA017  
16 x 16 x 11 cm  
6.3 x 6.3 x 4.3"  
\*Food safe



CHAMPAGNE CORK GIFT SET

BA019  
15,5 x 14,5 x 6 cm  
6.1 x 5.7 x 2.4"  
\*Gift packaged



2  
CHAMPAGNE COOLER

BA016  
40 x 22 x 20 cm  
15.7 x 8.7 x 7.9"



CHAMPAGNE MAGNUM COOLER

BA020  
52 x 52 x 27 cm  
20.5 x 20.5 x 10.6"



3  
TRAVEL SHAKER

CS011  
9 x 9 x 15,5 cm  
3.5 x 3.5 x 6.1"  
\*Food safe



4  
CLASSIC COCKTAIL SET

BA009  
12,5 x 12,5 x 41 cm  
4.9 x 4.9 x 16.1"



5  
TRAVEL ICE BUCKET

BA008  
15,5 x 15,5 x 15,5 cm  
6.1 x 6.1 x 6.1"  
\*Food safe



6  
COASTER, SET OF 3

BA018  
11 x 12,5 x 0,4 cm  
4.3 x 4.9 x 0.2"



GOLF BAR UTENCILS SET

BA021  
13 x 13 x 32 cm  
5.1 x 5.1 x 12.6"



3  
TRAVEL SHAKER

CS011  
9 x 9 x 15,5 cm  
3.5 x 3.5 x 6.1"  
\*Food safe

CHAMPAGNE MAGNUM COOLER

BA020  
52 x 52 x 27 cm  
20.5 x 20.5 x 10.6"

5  
TRAVEL ICE BUCKET

BA008  
15,5 x 15,5 x 15,5 cm  
6.1 x 6.1 x 6.1"  
\*Food safe

GOLF BAR UTENCILS SET

BA021  
13 x 13 x 32 cm  
5.1 x 5.1 x 12.6"



**1**  
ART DECO  
ICE BUCKET

**BA010**  
14,5 x 14,5 x 15,5 cm  
5.7 x 5.7 x 6.1"  
*\*Food safe*

**2**  
BLACK MIRROR  
SERVING TRAY

**BA013**  
29,5 x 21 x 6 cm  
11.6 x 8.3 x 2.4"

**3**  
BARTENDER  
GIFT SET

**BA011**  
10 x 14,5 x 2,5 cm  
3.9 x 5.7 x 1"  
*\*Gift packaged*

**4**  
COASTER,  
SET OF 3

**BA012**  
10 x 10 x 0,4 cm  
3.9 x 3.9 x 0.2"

**5**  
ART DECO  
COCKTAIL  
SHAKER

**CS012**  
8,5 x 8,5 x 24 cm  
3.3 x 3.3 x 9.4"  
*\*Food safe*

**6**  
THIRST  
EXTINGUISHER  
C. SHAKER

**CS001**  
10,5 x 10,5 x 38 cm  
4.1 x 4.1 x 15"  
*\*Not food safe*

**7**  
LIGHTHOUSE  
C. SHAKER

**CS010**  
10,5 x 10,5 x 35,5 cm  
4.1 x 4.1 x 14"  
*\*Food safe*



PEN AND UTENSILS HOLDER

**DA004**  
25 x 10,5 x 17 cm  
9.8 x 4.1 x 6.7"



DESK TRAY

**DA005**  
23 x 34 x 5 cm  
9 x 13.3 x 2"



JEWELRY BOX NAPOLEON

**AM034**  
7,2 x 8,9 x 7,4 cm  
2.8 x 3.5 x 2.9"  
*NEW ITEM*



TRAVELER'S CANDLE HOLDER

**AC160**  
9,5 x 9,5 x 5,5 cm  
3.7 x 3.7 x 2.2"  
*\*Pouch included*  
*\*Fully dismantlable*



TABLE BELL

**AC119**  
9 x 15,5 x 15 cm  
3.5 x 6.1 x 5.9"  
*NEW ITEM*



DRESSBOY WITH CLOCK

**MF188**  
34 x 49 x 140 cm  
13.4 x 19.3 x 55.1"  
*NEW ITEM*



BRONZE SHIP'S BELL 5"

**AC072B**  
12,8 x 12,8 x 12 cm  
5 x 5 x 4.7"



BRONZE SHIP'S BELL 6"

**AC073B**  
15 x 15 x 15 cm  
5.9 x 5.9 x 6.6"



PURSER'S BELL

**AC076**  
15 x 24 x 20 cm  
6 x 9.4 x 7.9"



SAILOR'S INN DESK BELL, BRONZE

**AC103**  
13 x 13 x 10,5 cm  
5.1 x 5.1 x 4.1"



JANE AUSTEN WRITING BOX

MG035A  
21 x 17 x 4 cm  
8.3 x 6.7 x 1.6"

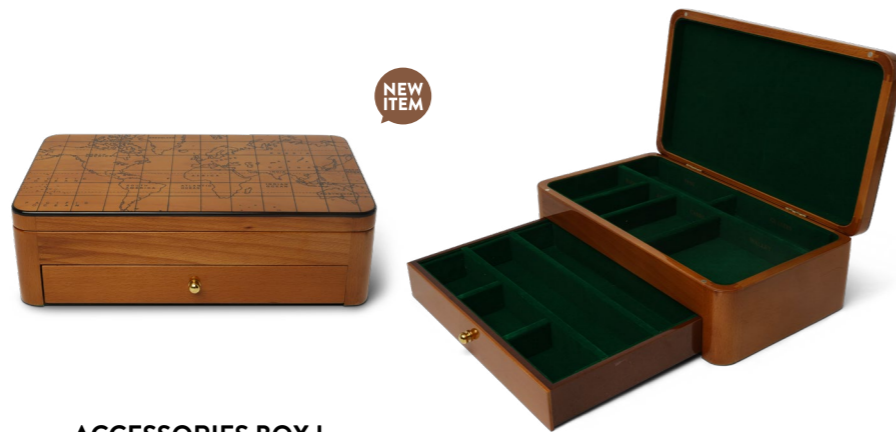

ACCESSORIES BOX L

AM037  
32,5 x 18,5 x 9,5 cm  
12.8 x 7.3 x 3.7"



SAFE BOOK MOON

MG025  
24 x 16 x 5 cm  
9.4 x 6.3 x 2"  
\*Safe inside



SAFE BOOK WORLD MAP

MG026  
24 x 16 x 5 cm  
9.4 x 6.3 x 2"  
\*Safe inside



WORLD MAP BOX, BLACK

AM035  
20,8 x 12,5 x 4,5 cm  
8.2 x 4.9 x 1.8"



ACCESSORIES BOX M

AM036  
32,5 x 18 x 4,5 cm  
2.8 x 7.1 x 1.8"



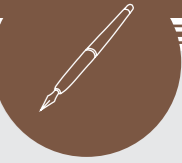

WINDSOR PROSE

MG029  
29,2 x 7,8 x 8 cm  
11,5 x 3,1 x 3"



WINDSOR TRAVEL, BLUE

MG127  
29,2 x 7,8 x 8 cm  
11,5 x 3,1 x 3"



THE DOUBLE WOOD SET

Includes:  
1x Wood Pen #1  
1x Wood Pen #2



MG142  
29,2 x 7,8 x 8 cm  
11,5 x 3,1 x 3"  
\*Gift packaged



WOOD SET #1

Includes:  
1x Wood Pen #3  
4x Points



MG143  
29,2 x 7,8 x 8 cm  
11,5 x 3,1 x 3"  
\*Gift packaged



WOOD SET #2

Includes:  
1x Wood Pen #4  
4x Points



MG144  
29,2 x 7,8 x 8 cm  
11,5 x 3,1 x 3"  
\*Gift packaged



FEATHER PEN SET

MG118  
25,5 x 8,5 x 6,5 cm  
10 x 3,3 x 2,6"



PALETTE FOR PENS 2

MG083  
25,6 x 8,9 x 7 cm  
9,3 x 3,5 x 2,6"



BRONZE SET

Includes:  
1x Bronze Pen  
4x Points



MG133  
29,2 x 7,8 x 8 cm  
11,5 x 3,1 x 3"  
\*Gift packaged



SILVER SET

Includes:  
1x Silver Pen  
4x Points



MG134  
29,2 x 7,8 x 8 cm  
11,5 x 3,1 x 3"  
\*Gift packaged



THE CYAN SET

Includes:  
1x Cyan Glass Pen  
1x Cyan Ink



MG138  
29,2 x 7,8 x 8 cm  
11,5 x 3,1 x 3"  
\*Gift packaged



COLORFUL PROSE

MG084  
25,6 x 8,9 x 7 cm  
9,3 x 3,5 x 2,6"



CAMPAIGN LAP DESK

MG076F  
40,5 x 25,5 x 10 cm  
15,9 x 10 x 3,9"



THE RED SET

Includes:  
1x Red Glass Pen  
1x Red Ink



MG136  
29,2 x 7,8 x 8 cm  
11,5 x 3,1 x 3"  
\*Gift packaged



THE DOUBLE RED SET

Includes:  
1x Red Spiral Glass Pen  
1x White Spiral Glass Pen



MG140  
29,2 x 7,8 x 8 cm  
11,5 x 3,1 x 3"  
\*Gift packaged



THE BLUE SET

Includes:  
1x Blue Glass Pen  
1x Blue Ink



MG137  
29,2 x 7,8 x 8 cm  
11,5 x 3,1 x 3"  
\*Gift packaged



THE DOUBLE BLUE SET

Includes:  
1x Blue Glass Pen  
1x Blue Spiral Glass Pen



MG139  
29,2 x 7,8 x 8 cm  
11,5 x 3,1 x 3"  
\*Gift packaged



## DETERMINE YOUR COURSE

Before the technological revolution transformed the way we navigate and understand the world, intrepid explorers relied on finely calibrated analogue instruments to guide them through uncharted territories. These tools were essential for measuring time, assessing weather conditions, reading maps, surveying their surroundings, and determining direction. In an era when precision was crucial, these instruments represented the height of craftsmanship and ingenuity, enabling explorers to push beyond the known world and venture into the unknown.

Authentic Models captures this spirit of adventure and discovery with its collection of fully functioning compasses, vision-enhancing aids, timepieces, and weather measuring devices. Each piece is a tribute to the vital role these inventions played in history, honoring their legacy with skillful craftsmanship and attention to detail. Beyond their practical functionality, these instruments charm with their aesthetic appeal, offering a touch of old-world elegance. Whether you are drawn to the art of navigation, fascinated by the science of timekeeping, or simply appreciate the beauty of finely crafted objects, these pieces invite you to rediscover the art of exploration and put your own skills to the test. Authentic Models brings the timeless spirit of adventure into the present, making these classic instruments a perfect blend of beauty and utility.



### COMPASS IN LEATHER CASE

CO038  
2,5 x 6,7 x 7,9 cm  
1 x 2,6 x 3,1"  
\*Gift packaged



### MARY ROSE SUNDIAL COMPASS

CO039  
1,8 x 4,7 x 4,7 cm  
0,7 x 1,8 x 1,8"  
\*Gift packaged



### DIAL COMPASS WITH CHAIN

CO046  
1,9 x 5 x 5 cm  
0,7 x 2 x 2"  
\*Gift packaged



### MINI PUSH BUTTON COMPASS

CO037  
1,7 x 4,6 x 4,6 cm  
0,6 x 1,8 x 1,8"  
\*Gift packaged



### PUSH BUTTON COMPASS LARGE

CO044  
1,7 x 6,4 x 6,4 cm  
0,7 x 2,5 x 2,5"  
\*Gift packaged



### PUSH BUTTON COMPASS SMALL

CO045  
1,8 x 4,8 x 4,8 cm  
0,7 x 1,9 x 1,9"  
\*Gift packaged



### SMALL COMPASS

CO002  
4,7 x 6,5 x 1,5 cm  
1,9 x 2,4 x 0,6"  
\*Gift packaged



### SMALL COMPASS, BRONZED

CO002B  
4,7 x 6,5 x 1,5 cm  
1,9 x 2,4 x 0,6"  
\*Gift packaged



### POCKET COMPASS

CO003  
8,5 x 10 x 1,5 cm  
3,3 x 3,9 x 0,6"  
\*Gift packaged



WWII COMPASS

CO014  
5,5 x 5,5 x 2 cm  
2,2 x 2,2 x 0,8"  
\*Gift packaged



SLIDE OUT COMPASS

CO035  
7 x 7 x 2,9 cm  
2,8 x 2,8 x 1,1"  
\*Gift packaged



EYE COMPASS LARGE

CO032  
11,3 x 11,3 x 4,1 cm  
4,5 x 4,5 x 1,6"



LEWIS & CLARK COMPASS

CO009  
7,8 x 7,8 x 2,3 cm  
3,1 x 3,1 x 0,9"  
\*Gift packaged



LIFEBOAT COMPASS

CO015  
12 x 12 x 8,5 cm  
4,7 x 4,7 x 3,3"



BRUNTON COMPASS

CO047  
3,2 x 10,8 x 11,2 cm  
1,3 x 4,3 x 4,4"



40-YEAR CALENDAR COMPASS, BRASS

CO031  
7,5 x 7,5 x 2 cm  
3 x 3 x 0,8"  
\*Gift packaged



ANTIQUE POCKET COMPASS

CO036  
5,6 x 5,6 x 1,9 cm  
2,2 x 2,2 x 0,7"  
\*Gift packaged



EYE COMPASS MEDIUM

CO033  
8,2 x 8,2 x 3,4 cm  
3,3 x 3,3 x 1,4"



COMPASS 3" FACET

CO040  
3,3 x 7,8 x 7,8 cm  
1,3 x 3 x 3"



3" DIA SPENCER COMPASS

CO041  
2,3 x 7,7 x 7,7 cm  
0,9 x 3 x 3"



CONVEX GLASS COMPASS

CO042  
3,5 x 9,5 x 9,5 cm  
1,4 x 3,7 x 3,7"



GIMBALLED DRUM COMPASS

CO043  
4,8 x 8,1 x 8,1 cm  
1,9 x 3,2 x 3,2"



18TH C. SUNDIAL & COMPASS

CO012A  
8,5 x 8,5 x 2,5 cm  
3,3 x 3,3 x 1"  
\*Gift packaged



MARINER'S COMPASS

CO019  
9 x 9 x 3 cm  
3,6 x 3,6 x 1,2"  
\*Gift packaged



EYE COMPASS SMALL

CO034  
5,9 x 5,9 x 2,9 cm  
2,4 x 2,4 x 1,2"  
\*Gift packaged



# Determine Your Course

GIFT BOXES



Contains 4 items:  
1x Sandtimer HG001B  
1x Compass CO007  
1x Fish Eye Magnifier  
1x Whistle BW002



## THE WALLACE GIFT BOX

**GB004**  
13,5 x 14 x 4,3 cm  
5,1 x 4,3 x 1,6"

# Determine Your Course

MAGNIFIERS



## VINTAGE TRAVEL MAGNIFIER

**AC090**  
13 x 5,5 x 1,9 cm  
5,3 x 2,3 x 0,8"  
*\*Gift packaged*



## DESK MAGNIFIER 4", BRASS

**AC043**  
10,5 x 10,5 x 7 cm  
4,2 x 4,2 x 2,8"



## DESK MAGNIFIER 3", BRASS

**AC044**  
8 x 8 x 5,5 cm  
3,2 x 3,2 x 2,2"



## MINI MAGNIFIER

**AC092**  
6,2 x 3,9 x 0,5 cm  
2,5 x 1,5 x 0,2"



## DESK MAGNIFIER 3", PEWTER

**AC047**  
8 x 8 x 5,5 cm  
3,2 x 3,2 x 2,2"





STAND MAGNIFIER

AC049  
15 x 9 x 23 cm  
5,9 x 3,5 x 9,1"



DOUBLE LENS MAGNIFIER

AC054  
3 x 2,2 x 12,1 cm  
1,2 x 0,9 x 4,8"  
\*Gift packaged



MAGNIFYING GLASS WITH STAND

AC099A  
25 x 11,4 x 18 cm  
9,8 x 4,5 x 7,1"



MAGNIFYING GLASS

AC099  
25 x 10 x 2,5 cm  
9,8 x 3 x 1"  
\*Gift packaged



OXFORD MAGNIFIER

AC091  
17 x 6,5 x 2,5 cm  
6,7 x 2,6 x 1"  
\*Gift packaged



CURVED HANDLE MAGNIFIER

AC059  
5 x 10 x 24,5 cm  
2 x 3,9 x 9,6"  
\*Gift packaged



HORN HANDLE MAGNIFIER

AC060  
3,2 x 7,8 x 23,2 cm  
1,3 x 3 x 9,2"  
\*Gift packaged



MAGNIFYING GLASS WITH STAND, BRONZED

AC099B  
25 x 11,4 x 18 cm  
9,8 x 4,5 x 7,1"



MAGNIFYING GLASS, BRONZED

AC099B  
25 x 10 x 2,5 cm  
9,8 x 3 x 1"  
\*Gift packaged



REGENCY MAGNIFIER

AC109  
27 x 11,4 x 1,2 cm  
10,6 x 4,5 x 0,5"  
\*Gift packaged



ROCCO MAGNIFIER, BRONZE

AC113  
13 x 5,3 x 1 cm  
5,1 x 2,1 x 0,4"  
\*Gift packaged



ROCCO MAGNIFIER, SILVER

AC114  
13 x 5,3 x 1 cm  
5,1 x 2,1 x 0,4"  
\*Gift packaged



READER'S GLASS

AC116  
22,5 x 8 x 2,5 cm  
8,9 x 3,1 x 1"  
\*Gift packaged



AVALON TELESCOPE

KA038  
100 x 82 x 156,3 cm  
39.4 x 32.3 x 61.5"  
\*Magnification 35x



MONOCULAR ON TRIPOD

KA039  
96 x 96 x 170 cm  
37.8 x 37.8 x 67"  
\*Magnification 20x



BINOCULAR ON TRIPOD

KA040  
170 x 75 x 75 cm  
67 x 29.5 x 29.5"  
\*Magnification 35x



VINTAGE DESK TELESCOPE

KA041  
32,5 x 25,5 x 38 cm  
12.8 x 10 x 15"



DESK TELESCOPE

KA044  
32,5 x 25,5 x 38 cm  
12.8 x 10 x 15"



FOLDING FLAP BINOCULAR

KA042  
9 x 12,5 x 12 cm  
3.5 x 4.9 x 4.7"



BINOCULAR PEARL

KA043  
11,5 x 17,5 x 10 cm  
4.5 x 6.9 x 3.9"



BRONZE SPYGLASS

KA023  
46 x 5,5 x 5,5 cm  
18 x 2.2 x 2.2"



OFFICER'S SPYGLASS

KA036  
38,8 x 4,3 x 4,3 cm  
15.3 x 1.7 x 1.7"



BRONZE SPYGLASS & STAND

KA023F  
54 x 17 x 11 cm  
21.3 x 6.7 x 4.3"

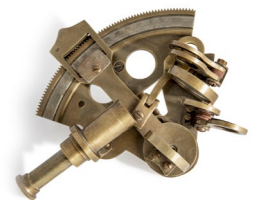

BRONZE POCKET SEXTANT

KA030  
11 x 11 x 6 cm  
4.3 x 4.3 x 2.2"



SEXTANT IN CASE

KA032  
15 x 15 x 8 cm  
6 x 6 x 3.3"



**BRASS 3 MINUTE SANDGLASS**

**HG001**  
3,5 x 3,5 x 9,5 cm  
1,4 x 1,4 x 3,7"  
*\*Gift packaged*



**BRONZE 3 MINUTE SANDGLASS**

**HG001B**  
3,5 x 3,5 x 9,5 cm  
1,4 x 1,4 x 3,7"  
*\*Gift packaged*



**BRONZED 30 MINUTE HOURGLASS**

**HG007**  
8 x 8 x 13,5 cm  
3,1 x 3,1 x 5,3"



**BRONZED 30 MINUTE HOURGLASS WITH STAND**

**HG008**  
18,5 x 13 x 25,5 cm  
7,3 x 5,1 x 10"



**LIQUOR HOUR GLASS**

**HG009**  
6,8 x 6,8 x 20 cm  
2,7 x 2,7 x 7,9"



**BRASS SANDTIMER, LARGE**

**HG010**  
4 x 4 x 12 cm  
1,8 x 1,8 x 2"



**COMPASS HOURGLASS**

**HG012**  
11,8 x 5 x 5 cm  
4,6 x 2 x 2"

NEW ITEM



**BRASS HOURGLASS**

**HG013**  
14,5 x 7,1 x 7,1 cm  
5,7 x 2,8 x 2,8"

NEW ITEM

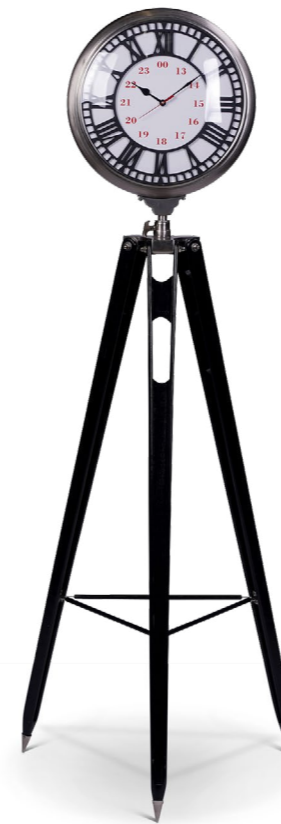

**WATERLOO CLOCK ON TRIPOD**

**SC066**  
165 x 60 x 60 cm  
65 X 23.6 X 23.6"



**WATERLOO CLOCK, S**

**SC067**  
19 x 9 x 21 cm  
7,5 x 3,5 x 8,3"  
*\*No batteries included*



**WATERLOO CLOCK, XL**

**SC068**  
40 x 12 x 46 cm  
15,8 x 4,7 x 18,1"  
*\*No batteries included*



**VICTORIAN DOME WATCH**

**SC054**  
13,5 x 13,5 x 12,5 cm  
5,3 x 5,3 x 4,9"



**WORLD CLOCK MADISON**

**SC062**  
22,2 x 7 x 17,2 cm  
8,8 x 2,8 x 6,8"

USA ONLY



**TABLE THERMOMETER**

**WG022**  
20 x 12 x 12 cm  
7,9 x 4,7 x 4,6"

NEW ITEM



**SUNNY HOURS**

**CO026**  
5,1 x 5,1 x 12,5 cm  
2 x 2 x 5"



**FITZROY'S STORM GLASS**

**SD001**  
8,5 x 5,8 x 14,8 cm  
3,4 x 2,3 x 5,8"



**NAVY CLOCK**

**SC048**  
16 x 16 x 10,3 cm  
6,3 x 6,3 x 4"  
*\*No batteries included*



**ART DECO FLIGHT CLOCK**

**AP104**  
35,5 x 7 x 10 cm  
14 x 2,8 x 4,1"



**PROPELLER CLOCK**

**AP111**  
30,5 x 5,5 x 9,5 cm  
12 x 2,2 x 3,7"

# Determine Your Course

TIME



NEW ITEM

**TABLE TOP GOLA WATCH**

SC070  
9,5 x 8 x 16 cm  
3.7 x 3.1 x 6.3"



NEW ITEM

**LENS WATCH ON STAND**

SC071  
8 x 9,8 x 18 cm  
3.1 x 3.9 x 7.1"



**50-YEAR CALENDAR**

BC002  
5,5 x 5,5 x 1,1 cm  
2.2 x 2.2 x 0.5"  
*\*Gift packaged*



USA ONLY

**50-YEAR CALENDAR**

BC006  
7,5 x 7,5 x 2,5 cm  
3 x 3 x 1"  
*\*Gift packaged*



**DESK STAND**

GL000  
11 x 11 x 17,5 cm  
4.3 x 4.3 x 6.9"

SC050 - SC051 - SC055 - SC057 - SC058



**STAND FOR EYE OF TIME, NICKEL**

GL000C  
11 x 11 x 17,5 cm  
4.3 x 4.3 x 6.9"

SC050 - SC051 - SC055 - SC057 - SC058



**STAND FOR EYE OF TIME, LIBRARY**

GL000L  
11 x 11 x 17,5 cm  
4.3 x 4.3 x 6.9"

SC052 - SC055



**STAND LIBRARY CLOCK, SILVER**

GL000S  
11 x 11 x 17,5 cm  
4.3 x 4.3 x 6.9"

SC052 - SC055 - SC063



# Determine Your Course

TIME



**EYE OF TIME**

SC050  
5 x 5 x 8 cm  
2 x 2 x 3.1"  
*\*Gift packaged*



**EYE OF TIME CLOCK, NICKEL**

SC051  
5 x 5 x 7,1 cm  
2 x 2 x 2.8"  
*\*Gift packaged*



**EYE OF TIME CLOCK, LIBRARY**

SC052  
7,5 x 7,5 x 11,5 cm  
3 x 3 x 4.5"  
*\*Gift packaged*



**PORTRHOLE EYE OF TIME, BRONZE**

SC055  
6,2 x 7,1 x 5 cm  
2,5 x 2,8 x 2"  
*\*Gift packaged*



**SAVOY POCKET WATCH**

SC057  
5 x 1,2 x 6,6 cm  
2 x 0,5 x 2,6"  
*\*Gift packaged*



**VICTORIAN POCKET WATCH**

SC058  
5,1 x 1,4 x 6,8 cm  
2 x 0,6 x 2,7"  
*\*Gift packaged*



**EYE OF TIME CLOCK, SILVER**

SC063  
7,5 x 7,5 x 11,5 cm  
3 x 3 x 4.5"



**EYE OF TIME CLOCK, BRASS**

SC063B  
7,5 x 7,5 x 11,5 cm  
3 x 3 x 4.5"  
*\*Gift packaged*







**AUTHENTIC MODELS HEAD OFFICE GLOBAL**

 **Authentic Models BV**  
 Ambachtsweg 37  
 3899 AM Zeewolde  
 The Netherlands  
 Phone +31 - (0)36 - 52 191 91  
 sales.eu@authenticmodels.com

**OFFICE UNITED STATES**

 **Authentic Models Americas Inc.**  
 1846 1st Street, Suite 246  
 Idaho Falls, ID 83401  
 Phone 541 - 686 - 4666  
 Toll-Free 800 - 888 - 1992  
 Fax 541 - 686 - 5111  
 sales.usa@authenticmodels.com

**JOIN US ONLINE**

-  [instagram.com/AMAuthenticModels](https://www.instagram.com/AMAuthenticModels)
-  [facebook.com/AMAuthenticModels](https://www.facebook.com/AMAuthenticModels)
-  [pinterest.com/am7394](https://www.pinterest.com/am7394)
-  [linkedin.com/company/authenticmodels](https://www.linkedin.com/company/authenticmodels)
-  <https://www.tiktok.com/@amauthenticmodels>

**#AUTHENTICMODELS**  
**SHARE YOUR FAVORITES WITH US**

**SALES OFFICES EUROPE**

 **Authentic Models Benelux**  
 Phone +31 - (0)36 52 191 73  
 Phone +31 - 6 330 123 10  
 sales.eu@authenticmodels.com

 **Authentic Models Germany (DACH)**  
 Phone +31 - (0)36 52 191 75  
 Phone +31 - 6 207 269 81  
 sales.eu@authenticmodels.com

 **Authentic Models France**  
 Phone +31 3 65 21 91 82  
 Phone +31 6 83 70 47 43  
 sales.eu@authenticmodels.com

 **Authentic Models Italy**  
 Phone +31 - (0)36 52 191 76  
 Phone +39 - 379 226 09 56  
 am-italy@authenticmodels.com

 **Authentic Models Spain**  
 Phone +31 - (0)36 52 191 76  
 Phone +34 - 93 81 24 366  
 am-spain@authenticmodels.com

 **Authentic Models UK & Ireland**  
 Phone +44 0 7507 123636  
 am-uk@authenticmodels.com

 **Authentic Models Asia-Pacific**  
 Phone +31 - (0)36 52 191 74  
 Phone +31 - 6 525 934 52  
 sales.eu@authenticmodels.com

Visit our website and stay informed about the latest collection.  
**WWW.AUTHENTICMODELS.COM**



# Authentic Models

DESIGNS WITH A STORY

## **COPYRIGHT**

No part of this publication may be reproduced in any manner or form whatsoever without the prior written permission of Authentic Models and other copyright holders. No rights can be derived from this publication.

## **DISCLAIMER**

Authentic Models makes every effort to maintain the accuracy and quality of the information provided in this catalogue. However, Authentic Models cannot guarantee and assumes no legal liability or responsibility for the accuracy or completeness of the information provided. It is important to bear in mind that the colours shown in this catalogue may not be an accurate representations of the actual colours of the items. The colour reproduction in this catalogue should only be used as a rough guide for selecting item colours. Our products are for indoor use only.

## **UNIQUE PRODUCTS**

Most products in the Authentic Models collection are handcrafted from natural materials. This means products are rarely completely identical and may show variance in colour, size or finish. We believe this aspect adds to the value and quality of these products. Small irregularities in shapes, surfaces and finishes are hallmarks of hand-craftsmanship and should not be considered defects.

## **COPYRIGHT**

Aucune partie de cette publication ne peut être reproduite de quelque manière ou sous quelque forme que ce soit sans l'autorisation écrite préalable d'Authentic Models et d'autres détenteurs de droits d'auteur. Aucun droit ne peut être dérivé de cette publication.

## **AVIS DE NON-RESPONSABILITÉ**

Authentic Models BV met tout en œuvre pour maintenir l'exactitude et la qualité des informations fournies dans ce catalogue. Toutefois, Authentic Models ne peut garantir et n'assume aucune responsabilité légale concernant l'exactitude ou l'exhaustivité des informations fournies.

Il est important de garder à l'esprit que les couleurs illustrées dans ce catalogue peuvent ne pas être des représentations exactes des couleurs réelles des articles. La reproduction des couleurs dans ce catalogue ne doit être utilisée que pour vous guider dans le choix des couleurs des articles. Nos produits sont destinés uniquement à un usage intérieur.

## **DES PRODUITS UNIQUES**

Certains produits de la collection Authentic Models sont fabriqués à la main à partir de matériaux naturels. Cela signifie que les produits sont rarement totalement identiques et peuvent présenter des différences de couleur, de taille ou de finition. Nous estimons que cet aspect ajoute de la valeur et de la qualité à ces produits. De petites irrégularités dans les formes, surfaces et finitions sont caractéristiques du travail artisanal et ne doivent pas être considérées comme des défauts.

## **COPYRIGHT**

Kein Teil dieser Veröffentlichung darf ohne vorherige schriftliche Zustimmung von Authentic Models und anderen Urheberrechtsinhabern auf irgendeine Weise oder in irgendeiner Form reproduziert werden. Aus dieser Veröffentlichung können keine Rechte abgeleitet werden.

## **HAFTUNGSAUSSCHLUSS**

Authentic Models BV bemüht sich nach Kräften, die Richtigkeit und Qualität der in diesem Katalog enthaltenen Informationen sicherzustellen. Authentic Models kann allerdings die Richtigkeit oder Vollständigkeit der vorgelegten Informationen nicht garantieren und übernimmt diesbezüglich keine gesetzliche Haftung oder Verantwortung.

Es ist wichtig zu berücksichtigen, dass die in diesem Katalog gezeigten Farben die tatsächlichen Farben der Artikel eventuell nicht genau wiedergeben. Die Farbwiedergabe in diesem Katalog sollte lediglich als grober Anhaltspunkt bei der Auswahl farbiger Artikel genutzt werden. Unsere Produkte sind nur für den Innenbereich bestimmt.

## **UNIKATE**

Einige Produkte in der Kollektion von Authentic Models werden aus natürlichen Materialien von Hand hergestellt. Das bedeutet, dass die Produkte nur selten vollständig identisch sind und sich eventuell in Bezug auf Farbe, Größe oder Oberflächengestaltung voneinander unterscheiden. Wir sind davon überzeugt, dass dies zum Wert und zur Qualität dieser Produkte beiträgt. Geringfügige Abweichungen in Bezug auf Formen, Oberflächen und Endbearbeitung sind Kennzeichen der Fertigung von Hand und sollten nicht als Mängel betrachtet werden.