





reddot winner 2023



reddot winner 2023

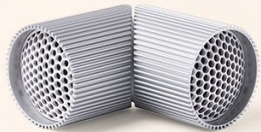

reddot winner 2024

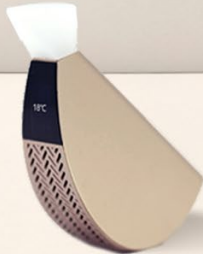

reddot winner 2024

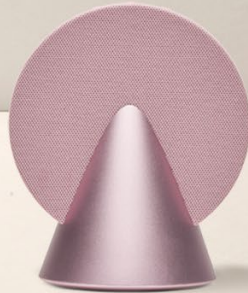

reddot winner 2024



**+30 YEARS OF GOOD DESIGN**

*+30 ANS DE GOOD DESIGN*

**LEXON®**

**1991**

LEXON is founded in Paris, France

*LEXON est créée à Paris, France*

**MoMA**

**1999**

Tykho radio is selected among MoMA's museum permanent collection

*La radio Tykho rejoint la collection permanente du MoMA*



**2000**

LEXON is the first object editor to make the cover of Time Magazine

*LEXON est le premier éditeur d'objets à faire la couverture du Time Magazine*



**2018**

BOW Group acquires LEXON

*Le Groupe BOW fait l'acquisition de LEXON*



**2024**

LEXON wins a record breaking 6 IF & 3 Red Dot Design Awards

*LEXON bat son record en remportant 6 IF & 3 Red Dot Design Awards*

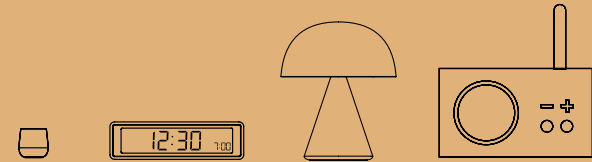

**EACH OF OUR ICONIC PRODUCTS HAS BEEN SOLD AT**  
*CHACUN DE NOS PRODUITS ICONIQUES A ÉTÉ VENDU À DES*

**MILLIONS**

*OF PIECES / DE PIÈCES*

**+235 INTERNATIONAL AWARDS**  
*RÉCOMPENSES INTERNATIONALES*



reddot winner



DESIGN PLUS



PROMOTIONAL GIFT AWARD



# A UNIQUE NETWORK OF DESIGNERS

## UN RÉSEAU UNIQUE DE DESIGNERS



### LIDIA GOMEZ

Lidia Gómez est une talentueuse designer industrielle espagnole reconnue pour son approche pointue et minimaliste. Son parcours technique a facilité la collaboration avec Lexon pour développer des objets surprenants, mais simples d'utilisation avec un parfait équilibre entre esthétique et fonction. *Lidia Gómez is a talented Spanish Industrial Designer recognized for her sharp and minimalist approach to design. Her tech background has facilitated the collaboration with Lexon to develop surprising, yet consumer-friendly objects with the perfect balance of aesthetics and function.*



### NEIL POULTON

Établi depuis 1992 en France, Neil Poulton est mondialement reconnu pour son travail sur les produits électroniques grand public et les luminaires. Ses marques de fabrique sont des produits minimalistes pour un usage quotidien, mêlant simplicité esthétique et innovation technique. Avec Lexon, Neil réinvente les objets de tous les jours en intégrant des performances de haute qualité dans des formes emblématiques. *Established since 1992 in France, Neil Poulton is a globally recognized for his work on consumer electronics products and lighting equipment. His trademarks are minimalist forms for everyday use, blending simple look and technical innovation. Together with Lexon, Neil is reinventing daily objects by embedding high quality performance into iconic shapes.*



### STEFANIE KAY

Stéphanie Kay est une jeune designer franco-britannique issue de l'ECAL, la célèbre école Suisse d'art et de design. Son travail a déjà été récompensé par plusieurs prix et sa collaboration avec Lexon consiste à proposer des objets élégants et modernes, avec un accent particulier sur l'expérience utilisateur et les fonctionnalités à valeur ajoutée. *Stéphanie Kay is a French & British young designer from ECAL, the renowned Swiss school of art & design. Her work has already been honored with several awards and her collaboration with Lexon is bringing sleek consumer objects to the market with a special focus on user experience and value-added features.*



### ALAIN BERTEAU

Alain Berteau est un architecte, designer et professeur bruxellois. Ses créations sont d'une apparente simplicité tout en offrant un très haut niveau d'innovation fonctionnelle. *Alain Berteau is a Brussels-based architect, product designer and professor. Alain's work is recognized for its combined simplicity and decisive functional innovation.*



### NATACHA POUTOUX & SACHA HOURCADE

natacha.sacha. est un duo de designers français talentueux aux compétences multiples. Leurs expériences en Matériaux de mobilier, d'architecture et l'attention qu'ils prêtent à la durabilité offrent une complémentarité singulière à tous les objets de la collection Horizon. *natacha.sacha. is a duo of talented French designers with a large set of skills. Their experiences in furniture, architecture and attention to sustainability is providing uncompromised complementary to all objects of the distinctive Horizon collection.*



### GUILLAUME DELVIGNE

Guillaume débute auprès de prestigieux designers comme George Sowden et Marc Newson. Il se lance en solo en collaborant aussi bien avec des industriels que des artisans. De sa rencontre avec Lexon naît la collection Nomaday, alliant pureté des lignes et innovation. *Guillaume started with prestigious designers like George Sowden and Marc Newson. He went solo, collaborating with both industrialists and craftsmen. From his meeting with Lexon comes the Nomaday collection, combining purity of lines and innovation.*



### NELSON FOSSEY

Nelson Fossey imagine des concepts où la technique se met au service de l'utilisateur. La collaboration avec Lexon permet de proposer des produits empreints d'une apparente simplicité, au caractère ludique et d'une facilité d'usage remarquable. *Nelson Fossey imagines concepts where technology is at the core of user experience. His collaboration with Lexon makes it possible to offer products with an apparent simplicity, a playful character and remarkable ease of use.*



### MANUELA SIMONELLI & ANDREA QUAGLIO

Ils conçoivent, en collaboration avec Lexon, des objets offrant à la fois un design raffiné et une simplicité d'usage. La diversité des produits imaginés, le choix inattendus des formes poétiques, la sélection méticuleuse des matériaux, permettent de créer une réelle transversalité à travers l'ensemble de nos catégories, une singularité propre à l'ADN de notre marque. *Together with Lexon, they craft objects offering both a refined design and simplicity of use. The diversity of products, the unexpected choice of poetic forms, and the meticulous selection of materials allow us to create real transversality across all our categories, a singularity specific to our brand DNA.*



### ADRIAN & JEREMY WRIGHT

Les deux frères ont suivi une formation d'ingénieur et ont de solides bases dans la compréhension de processus de fabrication. Leur approche est axée sur leur volonté de simplifier l'apparence et le fonctionnement des choses. *The brothers have a background in engineering and a solid understanding of the manufacturing process. Their approach is driven by a desire to reconsider and simplify how objects look and function.*



### YOANN JACQUON

Il s'intéresse particulièrement aux aspects culturels et techniques de la cohabitation entre l'homme et la nature, et comment le design peut jouer le rôle de médiateur entre ces deux entités. Le design représente l'expression de l'intelligence humaine dans son rapport à la nature. *He is specifically interested in the cultural and technical aspects of coexistence between man and nature, and how design can play the role of mediator between these two entities. Design represents the expression of human intelligence in its relationship to nature.*



### LUCA ARTIOLI

Une collaboration démarrée il y a plus de 20 ans avec un parcours sans faute dans la maîtrise de la bagagerie Lexon. *An harmonious collaboration started more than 20 years ago to master Lexon luggage collection.*



### VALENTINA & SIMONE SPALVIERI

Le studio Spalvieri/Del Ciotto est un lieu où idées, recherche et expérimentation se rencontrent. Leur travail se caractérise par une simplicité à la fois formelle et fonctionnelle, alliée à une forte sensibilité. *The studio Spalvieri/Del Ciotto is a place where ideas, research and experimentation meet. Their work is characterized by a simplicity that is both formal and functional, combined with strong sensitivity.*



### MARC BERTHIER

Une personnalité fondée sur le presque rien et l'intimité connue. Marc Berthier a marqué le design contemporain, par une identité forte et des choix de matériaux et couleurs entre discrétion et expression marquée du design. De la collaboration avec Lexon naissent des objets iconiques et intemporels. *A personality grounded in the almost imperceptible and the intimately known, Marc Berthier has shaped contemporary design with a distinctive identity, choices of materials and colors that balance between discretion and a pronounced expression of design. Iconic and timeless objects are born from the collaboration with Lexon.*

Sans oublier d'autres designers avec lesquels Lexon a eu le plaisir de collaborer ces 30 dernières années tels que : Philippe Starck, Pauline Deltour, Shoji Ito, Ionna Vautrin, Mathieu Lehanneur, Eugeni Quitllet, Elise Berthier & Anne Klepper, José Lévy, Marc Venot, Theo Williams et Claudio Gatto. *As well as other designers with whom Lexon had the pleasure to collaborate with, including: Philippe Starck, Pauline Deltour, Shoji Ito, Ionna Vautrin, Mathieu Lehanneur, Eugeni Quitllet, Elise Berthier & Anne Klepper, José Lévy, Marc Venot, Theo Williams and Claudio Gatto.*

# TODAY

A global retail expansion strengthened with the opening of new branded locations.

*Renforcement de notre présence à l'international notamment grâce à l'ouverture de nouveaux espaces de vente.*



**9000**

Point of sales  
Points de vente



**90**

Countries  
Pays



# LEXON, ALL DAY LONG

*LEXON, TOUT AU LONG DE LA JOURNÉE*

At LEXON, we create design objects that are meant to be part of your daily life, from morning till night. For that reason, we have rethought the way we define product categories and taken a transversal approach to better reflect how our objects fit your lifestyle.

*Chez LEXON, nous créons des objets design qui vous accompagnent au quotidien, du matin jusqu'au soir. Pour cette raison, nous avons repensé la façon dont nous définissons nos catégories produits et adopté une approche transversale pour mieux refléter la façon dont nos objets s'adaptent à votre style de vie.*

**WAKE-UP**  
SE RÉVEILLER



**LISTEN**  
ÉCOUTER



**ILLUMINATE**  
ÉCLAIRER



**CARE**  
PRENDRE SOIN DE SOI



**CHARGE**  
CHARGER



**WORK**  
TRAVAILLER

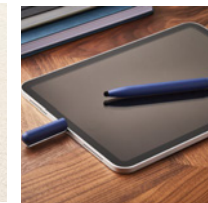

**MOVE**  
SE DÉPLACER



**CARRY**  
TRANSPORTER

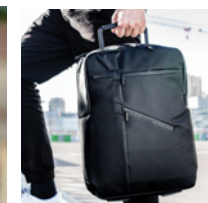

**WAKE-UP**  
*SE RÉVEILLER*



**WAKE-UP** *SE RÉVEILLER*

**NEW**

**FLIP  
CLASSIC**



**NEW**

**FLIP  
MINI**



**FLIP  
PREMIUM**



**MINUT**



**MINA  
SUNRISE**



**NEW**

**RAY  
CLOCK**



**NEW**

**CONIC  
CLOCK**



# FLIP CLASSIC

Reversible alarm clock / Réveil réversible



- RÉVEIL RÉVERSIBLE**  
  
 REVERSIBLE ALARM CLOCK
- ÉCRAN LCD ÉLECTROLUMINESCENT**  
  
 ELECTROLUMINESCENT LCD DISPLAY
- LUMINOSITÉ RÉGLABLE**  
  
 ADJUSTABLE BRIGHTNESS
- TOUCHEZ POUR RÉPÉTER L'ALARME & L'ÉCLAIRAGE**  
  
 TOUCH TO SNOOZE & LIGHT UP
- JUSQU'À 6 MOIS D'AUTONOMIE**  
  
 UP TO 6 MONTHS BATTERY LIFE
- RECHARGEABLE PAR USB-C**  
  
 RECHARGEABLE VIA USB-C

# FLIP CLASSIC

Design by Adrian & Jeremy Wright



Réveil réversible - Faces ON/OFF - Ecran LCD - 3 niveaux de luminosité - Touchez pour répéter l'alarme & l'éclairage - Autonomie : jusqu'à 6 mois - Temps de charge : 4h - Rechargeable par USB-C (cable inclus). Matériaux: ABS.

Reversible alarm clock - ON/OFF faces - LCD display - 3 Brightness levels - Touch sensor snooze / light - Battery life: up to 6 months - Charging time: 4h - Rechargeable via USB-C (cable included). Material: ABS.

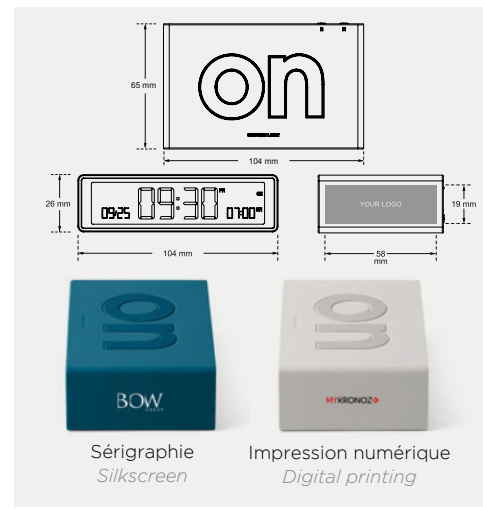

10,4 x 6,5 x 2,6 cm / I.P. Brut : 156 g  
 4.09 x 5.55 x 1.02" / G.W. : 0.34 lbs

Colisage : 40 p/aprox 8.1kg  
 Carton : 40p/17.86 lbs

# FLIP MINI

Mini reversible alarm clock / *Mini réveil réversible*



RÉVEIL RÉVERSIBLE



REVERSIBLE ALARM CLOCK

ÉCRAN LCD ÉLECTROLUMINESCENT



ELECTROLUMINESCENT LCD DISPLAY

LUMINOSITÉ RÉGLABLE



ADJUSTABLE-BRIGHTNESS

TOUCHEZ POUR RÉPÉTER L'ALARME & L'ÉCLAIRAGE



TOUCH TO SNOOZE & LIGHT UP

JUSQU'À 6 MOIS D'AUTONOMIE



UP TO 6 MONTHS BATTERY LIFE

RECHARGEABLE PAR USB-C



RECHARGEABLE VIA USB-C



# FLIP MINI

Design by Adrian & Jeremy Wright



Mini réveil réversible de voyage - Faces ON/OFF - Ecran LCD - 3 niveaux de luminosité - Touchez pour répéter l'alarme & l'éclairage - Autonomie : jusqu'à 6 mois - Temps de charge : 2h - Rechargeable par USB-C (cable inclus). Matériaux: ABS

*Mini reversible alarm clock - ON/OFF faces - LCD display - 3 Brightness levels - Touch sensor snooze / light - Battery life: up to 6 months - Charging time: 2h - Rechargeable via USB-C (cable included). Material: ABS.*

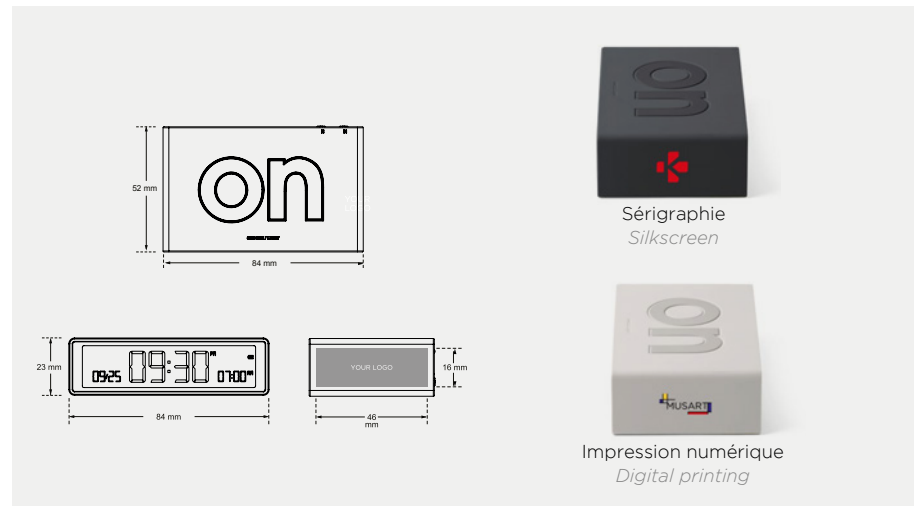

8 x 9.9 x 2.3 cm I.P. Brut : 105 g  
3,14 x 1,95 x 0,90" / G.W. : 0,23 lbs

Colisage : 40 pcs / 6.4 kg  
Carton : 40p/ 14.10 lbs

# FLIP PREMIUM

Reversible LCD alarm clock in aluminum / Réveil LCD réversible en aluminium

# FLIP PREMIUM

Design by Adrian & Jeremy Wright



AWARDS



reddot winner 2022



RÉVEIL RÉVERSIBLE



REVERSIBLE ALARM CLOCK

ÉCRAN VA LCD PURE BLACK



PURE BLACK VA LCD DISPLAY

CAPTEUR SONORE POUR ACTIVATION DE L'ÉCRAN



SOUND SENSOR TO ACTIVATE SCREEN

RÉPÉTITION DE L'ALARME & ÉCLAIRAGE



SNOOZE & LIGHT UP

VOLUME D'ALARME RÉGLABLE



ADJUSTABLE ALARM VOLUME

JUSQU'À 6 MOIS D'AUTONOMIE



UP TO 6 MONTHS BATTERY LIFE

RECHARGEABLE PAR USB-C



RECHARGEABLE VIA USB-C

FINITION ALUMINIUM



ALUMINIUM FINISHING



Réveil LCD réversible - Faces ON/OFF - Ecran VA LCD pure black - Capteur sonore pour activation de l'écran - Commandes tactiles pour répéter l'alarme et ajuster la luminosité - Sonneries d'alarme avec volume ajustable - Mode nuit - Autonomie : jusqu'à 6 mois - Rechargeable par USB-C (câble inclus). Matériaux : Aluminium - PC.

Reversible LCD alarm clock - ON/OFF faces - Pure VA LCD display - Sound sensor to wake-up screen - Touch control for snooze and dimmer - 3 alarm tones with volume adjustment - Night mode - Battery life: up to 6 months - Rechargeable via USB-C (cable included). Material: Aluminum - PC.

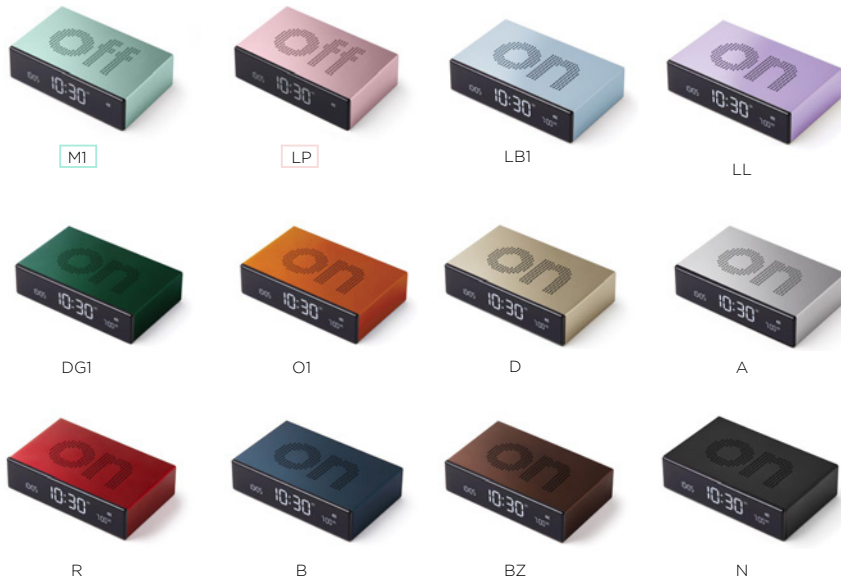

New colors / Nouvelles couleurs

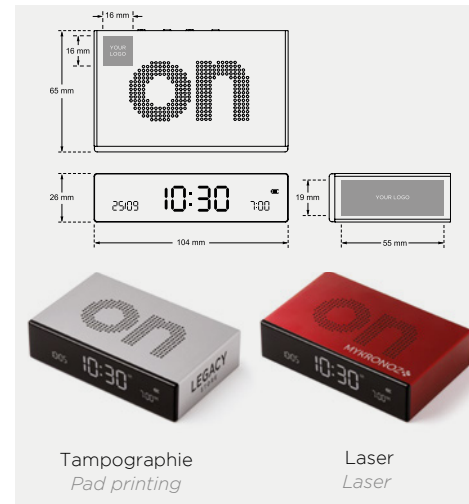

10,4 x 6,5 x 2,6 cm | P.Brut: 228 g  
4.09 x 2.56 x 1.02" | G.W: 0.4 lbs



Colisage : 40p/11 kg  
Carton : 40p/24.25 lbs

# MINUT

Mini alarm clock / Mini réveil

# MINUT

Design by Manuela Simonelli & Andrea Quaglio



AWARD



reddot winner 2023



- FORMAT DE POCHE**  
  
POCKET-SIZED
- ÉCRAN VA LCD PURE BLACK**  
  
PURE BLACK VA LCD DISPLAY
- RÉPÉTITION DE L'ALARME & ÉCLAIRAGE**  
  
SNOOZE & LIGHT UP
- JUSQU'À 6 MOIS D'AUTONOMIE**  
  
UP TO 6 MONTHS BATTERY LIFE
- RECHARGEABLE PAR USB-C**  
  
RECHARGEABLE VIA USB-C
- FINITION ALUMINIUM**  
  
ALUMINIUM FINISHING

Réveil compact avec écran LCD noir et batterie rechargeable intégrée - Commandes tactiles - Fonction snooze - Autonomie: Jusqu'à 6 mois - Temps de charge: 3h - Rechargeable par USB-C. Matériaux : Aluminium - ABS.

Compact size alarm clock with full black LCD display - Rechargeable built-in battery - Touch controls - Snooze function - Battery life: Up to 6 months - Charging time: 3h - Rechargeable via USB-C. Material: Aluminum / ABS.

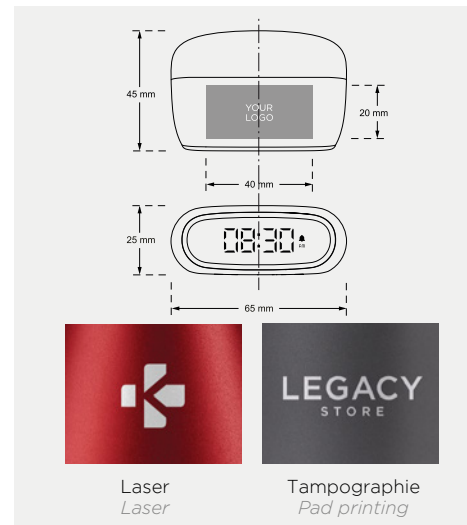

6.5 x 4.5 x 2.5 cm / P. Brut : 95 g  
2.36 x 1.57 x 0.79" / G.W: 0.21 lbs

Colisage: 40p / Env. 4.1 kg  
Carton: 40p / Approx. 9.04 lbs

# MINA SUNRISE

Sunrise alarm clock / Lampe réveil simulateur d'aube



SIMULATION DE L'AUBE ET DU CRÉPUSCULE



SUNRISE & SUNSET SIMULATION

MÉLODIES ET SONS NATURELS



MELODIES & NATURAL SOUNDS

RÉPÉTITION DE L'ALARME



SNOOZE & DIMMER

LAMPE LED AVEC 9 COULEURS D'ÉCLAIRAGE



LED LAMP WITH 9 COLORS

PORT DE CHARGE USB-C



USB-C CHARGING PORT

FINITION ALUMINIUM



ALUMINIUM FINISHING



New colors / Nouvelles couleurs

# MINA SUNRISE

Design by Manuela Simonelli & Andrea Quaglio



Lampe réveil simulateur d'aube - Écran LCD VA pur - Simulation du lever et du coucher du soleil - Mélodies & sons naturels - Lampe avec 9 couleurs de LED - Puissance lumineuse maximale : 70 lm - Variateur d'intensité - Commandes tactiles - Rechargeable - Jusqu'à 4 mois d'autonomie - Temps de charge : 5h - Rechargeable par USB-C (câble inclus) - Matériaux : Aluminium - ABS.

Sunrise alarm clock - Pure VA LCD display - Sunrise & Sunset simulation - Melodies & natural sounds - Lamp with 9 LED colors - Maximum light output: 70 lm - Dimmer - Touch controls - Rechargeable - Up to 4 months of battery life - Charging time: 5h - Rechargeable via USB-C (cable included) - Material: Aluminum - ABS.

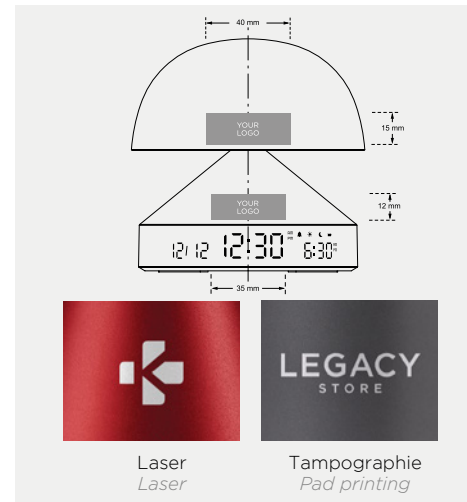

Ø11 x 9.3 cm / P. Brut : 430 g  
Ø4.33 x 4.33" / G.W: 0.95 lbs



Colisage: 20p / 9.6 kg  
Carton: 20p / Approx. 2117 lbs

# RAY CLOCK

Alarm clock with thermometer and hygrometer  
Réveil avec thermomètre et hygromètre

# RAY CLOCK

Design by neil poulton



ÉCRAN VA LCD  
PURE BLACK



PURE BLACK  
VA LCD DISPLAY

MÉLODIES ET SONS  
NATURELS



MELODIES &  
NATURAL SOUNDS

RÉPÉTITION DE  
L'ALARME  
& ÉCLAIRAGE



SNOOZE  
& LIGHT UP

SUIVI DE LA TEMPÉRATURE  
INTÉRIEURE ET DE  
L'HUMIDITÉ



INDOOR TEMPERATURE &  
HUMIDITY MONITORING

RECHARGEABLE  
PAR USB-C



RECHARGEABLE  
VIA USB-C

FINITION  
ALUMINIUM



ALUMINIUM  
FINISHING



VG3



OB3



SR3



MN3



RA3

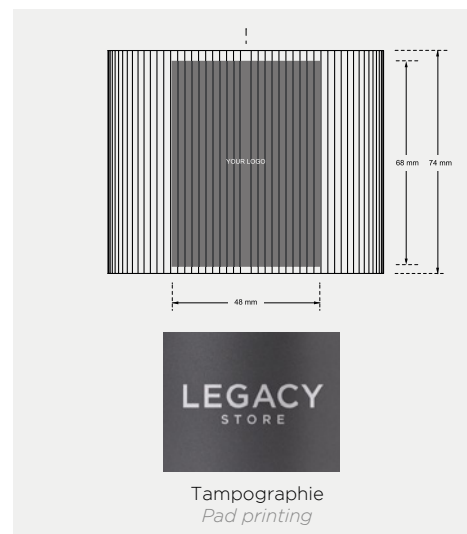

9 x 4.4 x 7.4 cm / P. Brut: 300 g  
3.54 x 1.73 x 2.91" / G.W: 0.66 lbs



Colisage: 40 pcs / Env. 13.6 kg  
Carton: 40 pcs / Approx. 29.98 lbs

Réveil LCD avec affichage température / humidité - Fonction snooze - Inclinaison pour activer/désactiver l'alarme - Mélodies & sons naturels - Affichage de la température intérieure et de l'humidité relative - Autonomie : Jusqu'à 6 mois - Rechargeable par USB-C (câble inclus) - Temps de charge : 4h - Matériaux : Aluminium - ABS.

LCD alarm clock with temperature / humidity display - Snooze function - Tilt to activate/deactivate alarm - Melodies & natural sounds - Indoor temperature and relative humidity display - Battery life: Up to 6 months - Rechargeable via USB-C (cable included) - Charging time: 4h - Material: Aluminum - ABS.

# CONIC CLOCK

Radio alarm clock with FM & built-in Bluetooth® speaker  
 Radio réveil avec FM & enceinte Bluetooth® intégrée



- RADIO FM**



FM RADIO
- ENCEINTE BLUETOOTH®**



BLUETOOTH SPEAKER
- ÉCRAN VA LCD PURE BLACK**



PURE BLACK VA LCD DISPLAY
- MÉLODIES ET SONS NATURELS**



MELODIES & NATURAL SOUNDS
- RÉPÉTITION DE L'ALARME & ÉCLAIRAGE**



SNOOZE & LIGHT UP
- SUIVI DE LA TEMPÉRATURE INTÉRIEURE ET DE L'HUMIDITÉ**



INDOOR TEMPERATURE & HUMIDITY MONITORING
- PORT DE CHARGE USB-C**



USB-C CHARGING PORT
- FINITION ALUMINIUM**



ALUMINIUM FINISHING

# CONIC CLOCK

Design by Lidia Gomez



Radio réveil avec FM & enceinte Bluetooth® intégrée - Double alarme avec radio FM ou mélodies & sons naturels - Grand écran LCD - Luminosité ajustable - Affichage de la température intérieure et de l'humidité relative - Commandes tactiles pour un accès facile aux modes Bluetooth/radio FM et aux réglages des paramètres - Rechargeable - Alimenté par USB-C (câble inclus) - Matériaux: Aluminium-ABS. Marquage conseillé : laser - tampographie.

Radio alarm clock with FM & built-in Bluetooth® speaker - Dual alarm with FM radio or melodies & natural sounds - Large LCD display - Adjustable brightness - Indoor temperature and relative humidity display - Touch controls for easy access to Bluetooth/FM radio modes and device settings - Rechargeable - Powered by USB-C (cable included) - Material: Aluminum - ABS. Suggested branding: laser - pad print.



GH3



CR3



PB3



L3



GA3



PG3

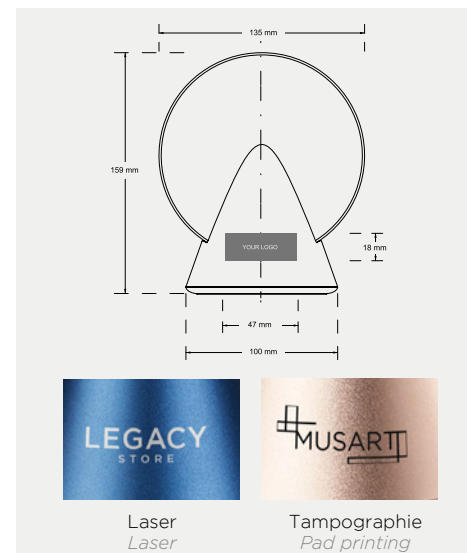

Ø13.5 x 15.9 cm / P. Brut: 700 g  
 Ø5.31 x 6.263" / G.W: 1.54 lbs

Colisage: 12 pcs / Env. 11 kg  
 Carton: 12 pcs / Approx. 24.25 lbs

**LISTEN**  
ÉCOUTER



**LISTEN** ÉCOUTER

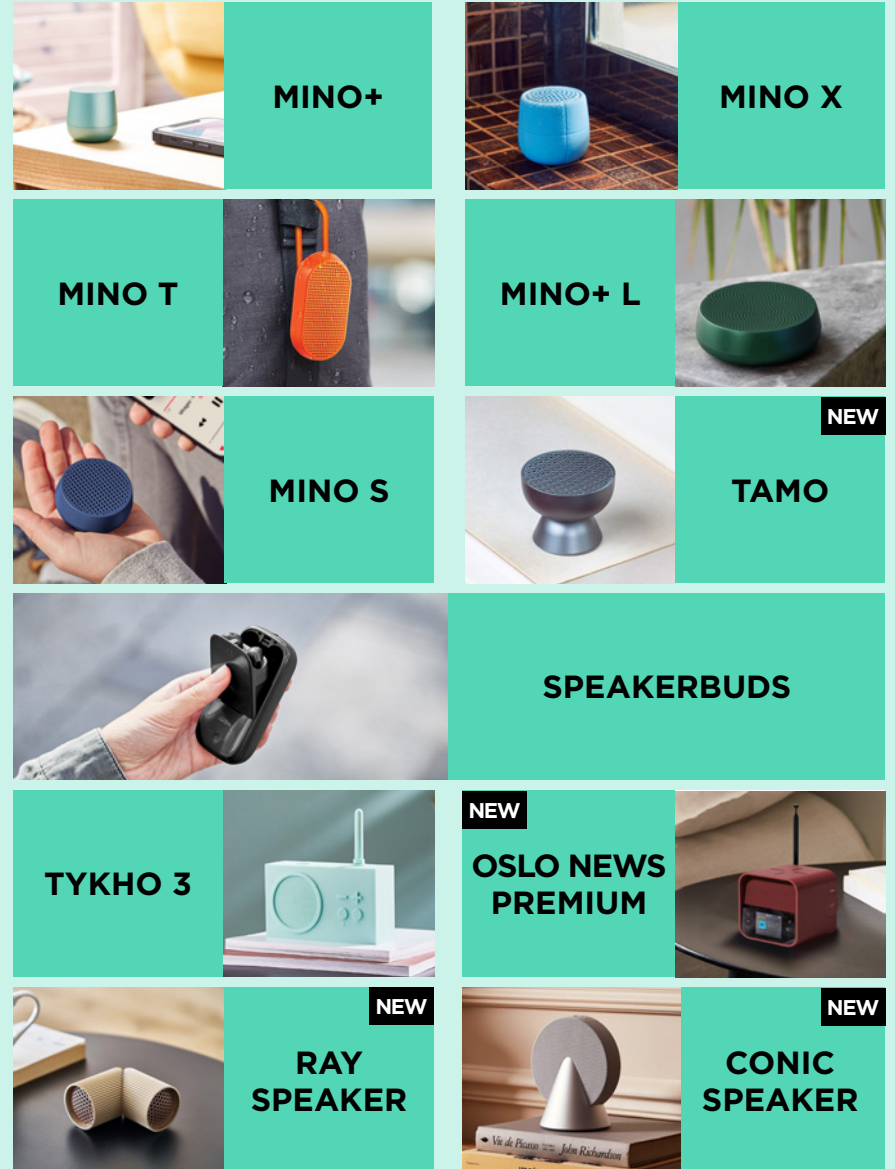

# MINO+

Mini Bluetooth® speaker / Mini enceinte Bluetooth®

# MINO+

Design by Manuela Simonelli & Andrea Quaglio



AWARD  
reddot winner 2021

- ENCEINTE BLUETOOTH**

BLUETOOTH SPEAKER
- APPARAÏBLE PAR TWS**

PAIRABLE VIA TWS
- MICRO MAINS-LIBRES**

HANDS-FREE MIC
- DÉCLENCHEUR SELFIE**

SELFIE REMOTE
- PORT USB-C**

USB-C PORT
- RECHARGEABLE PAR INDUCTION**

WIRELESSLY RECHARGEABLE
- FINITION EN ALUMINIUM**

ALUMINUM FINISHING

Enceinte Bluetooth® rechargeable par induction - Apparaïble - Micro mains-libres - Déclencheur selfie - Autonomie : 3h - Temps de charge : 1h - Rechargeable par USB-C (câble inclus) ou par induction Matériaux : Aluminium - ABS.

Wirelessly rechargeable Bluetooth® speaker - Pairable - Hands-free mic - Selfie control - Battery life: 3h - Charging time: 1h - Rechargeable via USB-C (cable included) or wirelessly. Material: Aluminum - ABS.



Colors on request / Couleurs sur demande

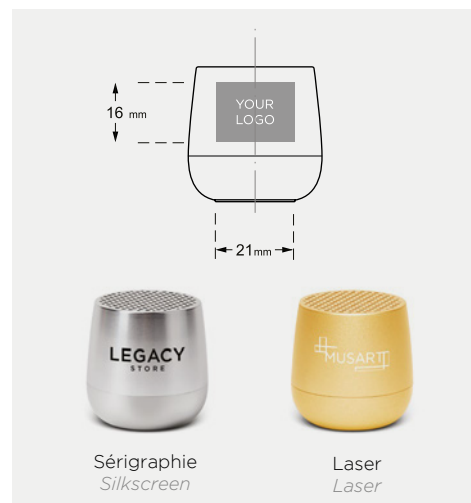

3,7 x 3,7 cm | P. Brut : 73 g  
Ø1.46 x 1.46" | G.W : 0.16 lbs



Colisage : 40p / 3,740 kg  
Carton : 40p / 8.4 lbs

# MINO X

Floating Bluetooth® speaker / Enceinte Bluetooth® flottante

# MINO X

Design by Manuela Simonelli & Andrea Quaglio

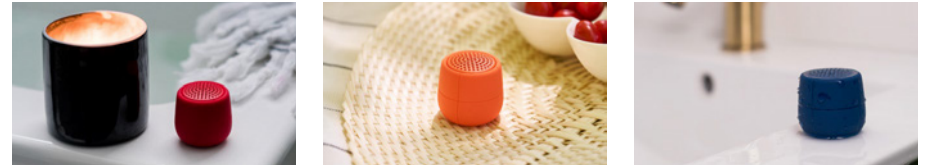

Enceinte Bluetooth® flottante - Résistance à l'eau IPX7 - Appairable - Rechargeable - Micro mains-libres - Déclencheur selfie - Autonomie : 3h - Temps de charge : 1h - Rechargeable par USB-C (câble inclus) - Matériaux : ABS - gomme rebondissante - finition silicone.

Floating Bluetooth® speaker - Water resistance IPX7 - Pairable - Rechargeable - Hands-free mic - Selfie control - Battery life: 3h - Charging time: 1h - Rechargeable via USB-C (cable included) - Material: ABS - bouncy rubber - silicone finishing.

- ENCEINTE BLUETOOTH**



BLUETOOTH SPEAKER
- APPAIRABLE PAR TWS**



PAIRABLE VIA TWS
- MICRO MAINS-LIBRES**



HANDS-FREE MIC
- DÉCLENCHEUR SELFIE**



SELFIE REMOTE
- RECHARGEABLE PAR USB-C**



RECHARGEABLE VIA USB-C
- RÉSISTANCE À L'EAU IPX7**



IPX7 WATER RESISTANT



Ø 4,3 x 4 cm | P. Brut: 135 g  
Ø 1.6 x 1.5" | G.W: 0.29 lbs

Colisage : 40p / 6,19 kg  
Carton : 40p / 13,8 lbs

# MINO T

Bluetooth® speaker with built-in carabiner / *Enceinte Bluetooth® avec mousqueton intégré*

# MINO T

Design by Manuela Simonelli & Andrea Quaglio



AWARD  
reddot winner 2021

- ENCEINTE BLUETOOTH**

BLUETOOTH SPEAKER
- APPARABLE PAR TWS**

PAIRABLE VIA TWS
- MOUSQUETON EN ACIER INOXYDABLE**

STAINLESS STEEL CARABINER
- MICRO MAINS-LIBRES**

HANDS-FREE MIC
- DÉCLENCHEUR SELFIE**

SELFIE REMOTE
- RECHARGEABLE PAR USB-C**

RECHARGEABLE VIA USB-C
- ADAPTÉE À UN USAGE EXTÉRIEUR (IPX4)**

SUITABLE FOR OUTDOOR USE (IPX4)

Enceinte Bluetooth® avec mousqueton intégré - Appairable par TWS - Micro mains-libres - Déclencheur selfie - Résistance à l'eau IPX4 - Autonomie : 5h - Temps de charge : 2h - Rechargeable par USB-C (câble inclus) - Matériaux : Socle en ABS - Mousqueton en ABS - Alliage de zinc.

*Bluetooth® speaker with integrated carabiner - Pairable via TWS - Hands-free mic - Selfie control - Water resistance IPX4 - Playtime: 5h - Charging time: 2h - Rechargeable via USB-C (cable included) - Material: ABS stand - ABS - Zinc alloy hook.*

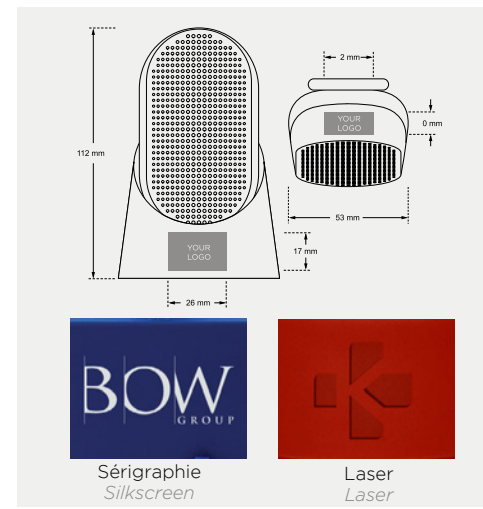

5,3 x 2,9 x 9,7cm | P. Brut : 310 g  
2.08 x 1.14 x 3.81" | G.W : 0.7 lbs

Colisage: 20p / 6,640 kg  
Carton : 20p/ 14,55 lbs

# MINO+ L

Portable Bluetooth® speaker / Enceinte Bluetooth® nomade

# MINO+ L

Design by Manuela Simonelli & Andrea Quaglio



- ENCEINTE BLUETOOTH**  
 BLUETOOTH SPEAKER
- APPAIRABLE PAR TWS**  
 PAIRABLE VIA TWS
- MICRO MAINS-LIBRES**  
 HANDS-FREE MIC
- DÉCLENCHEUR SELFIE**  
 SELFIE REMOTE
- PORT DE CHARGE USB-C**  
 USB-C CHARGING PORT
- RECHARGEABLE PAR INDUCTION**  
 WIRELESSLY RECHARGEABLE
- ADAPTÉE À UN USAGE EXTÉRIEUR (IPX4)**  
 SUITABLE FOR OUTDOOR USE (IPX4)
- FINITION EN ALUMINIUM**  
 ALUMINUM FINISHING



Enceinte Bluetooth® adaptée pour l'extérieur - Fonction TWS pour une expérience stéréo - Batterie rechargeable - Résistance à l'eau classée IPX4 pour un usage en extérieur (conception étanche aux éclaboussures et au sable) - Micro mains-libres intégré pour les conférences téléphoniques - Autonomie: 5h - Temps de charge: 2h - Rechargeable sur port USB-C (câble inclus) ou par induction. Matériaux : Aluminium - ABS.

Outdoor friendly Bluetooth speaker - TWS compatible for stereo effect - Rechargeable battery and IPX4 rating for outdoor usage (spillproof and sand proof design) - Hands-free and built-in microphone for conference calls - Battery life: 5h - Charging time: 2h - Rechargeable on USB-C port (cable included) or wirelessly. Material: Aluminum - ABS.

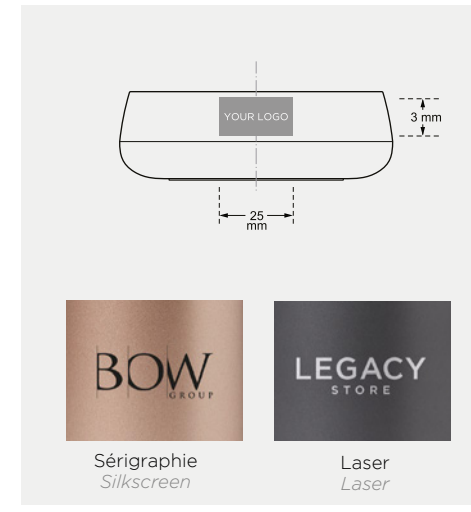
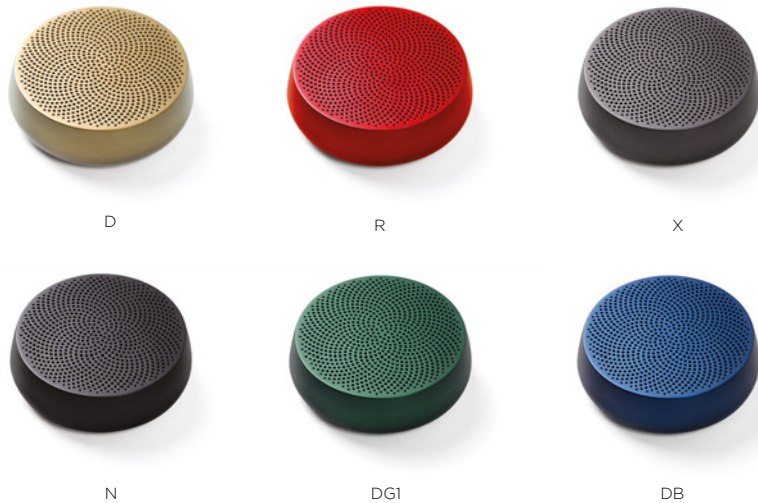

Ø9,3 x 3 cm / P.Brut: 358 g  
Ø3,66 x 1,18" / G.W : 0.8 lbs

Colisage: 20p / 7 kg  
Carton : 20p / 15,43 lbs

# MINO S

Pocket-sized Bluetooth® speaker / Enceinte bluetooth® de poche

# MINO S

Design by Manuela Simonelli & Andrea Quaglio

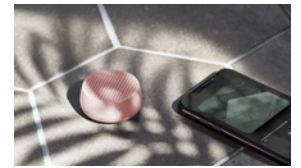
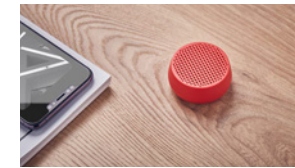
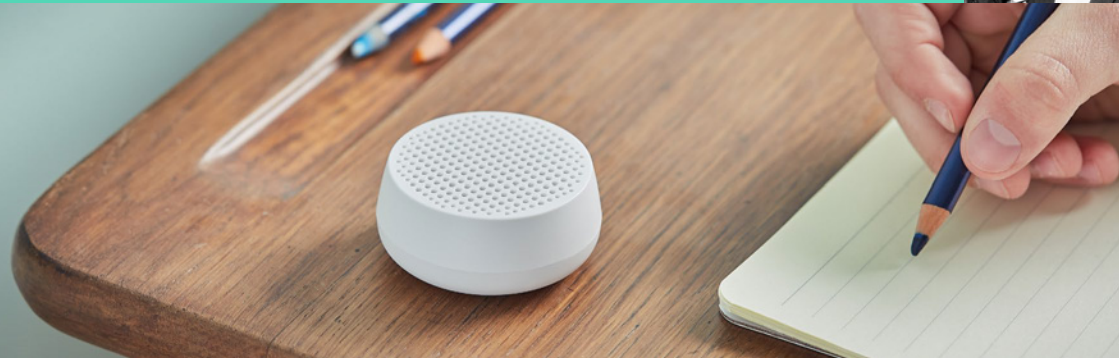
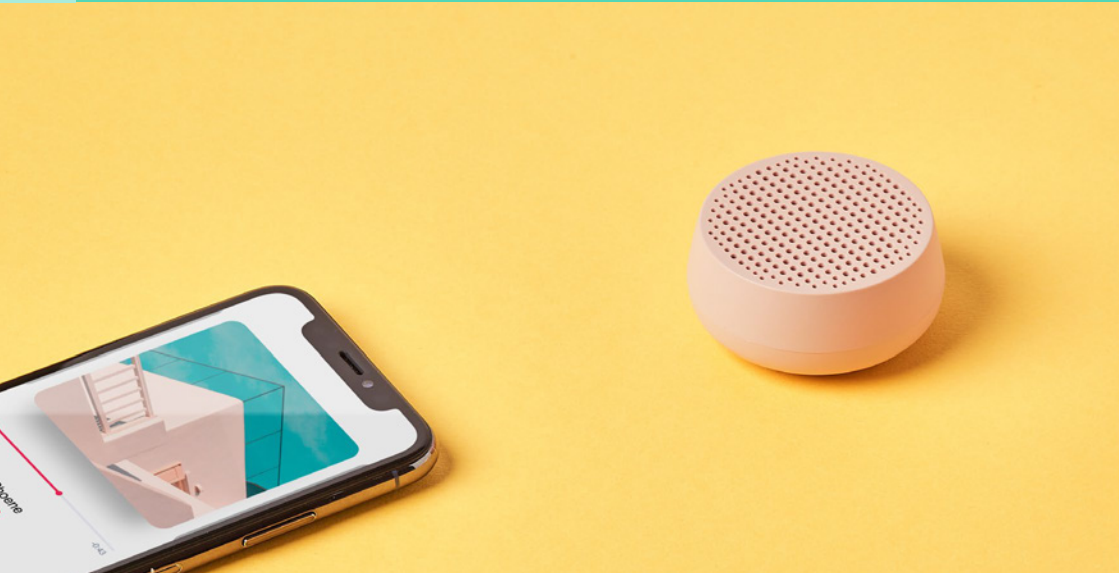

ENCEINTE  
BLUETOOTH



BLUETOOTH  
SPEAKER

APPAIRABLE  
PAR TWS



PAIRABLE  
VIA TWS

MICRO  
MAINS-LIBRES



HANDS-FREE  
MIC

DÉCLENCHEUR  
SELFIE



SELFIE  
REMOTE

RECHARGEABLE  
PAR USB-C



RECHARGEABLE  
VIA USB-C

Enceinte Bluetooth® de poche - Appairable par TWS - Rechargeable - Micro mains-libres - Déclencheur selfie - Autonomie : 3h - Temps de charge : 1h - Rechargeable par USB-C (câble inclus) - Matériaux : ABS.

Pocket-sized Bluetooth® speaker - Pairable via TWS - Rechargeable - Hands-free mic - Selfie control - Playtime: 3h - Charging time: 1h - Rechargeable via USB-C (cable included) - Material: ABS.



N9



DB9



K9



PO



R9



MW

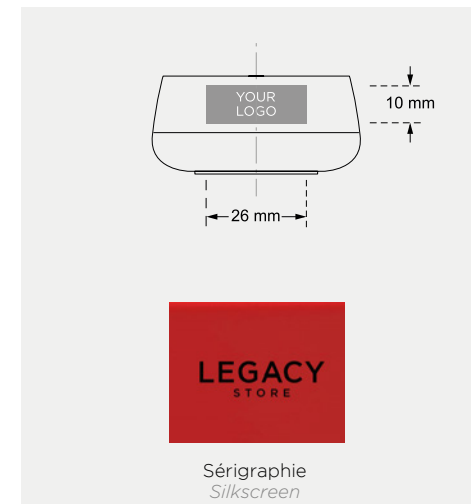

Ø5,4 x 2,5 cm | P.Brut: 85 g  
Ø2,1 x 0,98" | G.W : 0.19 lbs



Colisage: 40p / 4 kg  
Carton : 40p / 8.75 lbs

# TAMO

Infinitely pairable mini Bluetooth® speaker  
Mini enceinte Bluetooth® connectable à l'infini

**TAMO**  
Design by Manuela Simonelli & Andrea Quaglio



Connect multiple Tamo together easily!  
Connectez facilement plusieurs Tamo ensemble !



- ENCEINTE BLUETOOTH**  
BLUETOOTH SPEAKER
- CONNECTABLE À L'INFINI**  
INFINITELY PAIRABLE
- CONTRÔLE TACTILE POUR LES COMMANDES AUDIO**  
TOUCH CONTROL FOR AUDIO CONTROLS
- MICRO MAINS-LIBRES**  
HANDS-FREE MIC
- DÉCLENCHEUR SELFIE**  
SELFIE REMOTE
- RECHARGEABLE PAR USB-C**  
RECHARGEABLE VIA USB-C
- RECHARGEABLE PAR INDUCTION**  
WIRELESSLY RECHARGEABLE
- FINITION EN ALUMINIUM**  
ALUMINIUM FINISHING

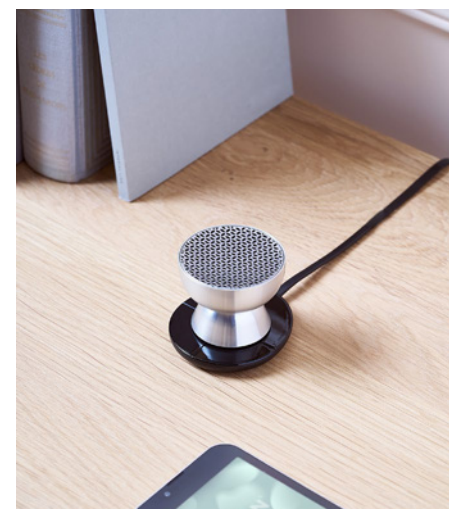

Mini enceinte Bluetooth® connectable à l'infini - Commande tactile sur la base pour les commandes audio et ajustement du volume - Micro mains libres - Déclencheur selfie - Autonomie : Jusqu'à 3h - Rechargeable par USB-C (câble inclus) ou par induction - Temps de charge : 1h. Matériaux: Aluminium-ABS. Marquage conseillé: sérigraphie - laser.

Infinitely pairable mini Bluetooth® speaker - Touch control on base for audio controls and volume adjustment - Hands-free microphone - Selfie control - Battery life: Up to 3h - Rechargeable via USB-C (cable included) or wirelessly - Charging time: 1h - Material: Aluminum-ABS. Suggested branding: silkscreen - laser.

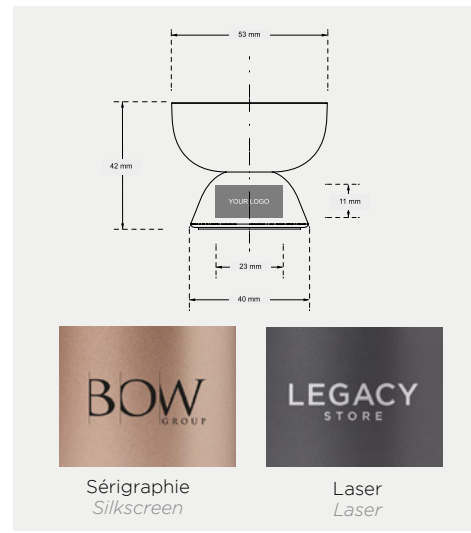

Ø5.3 x 42 cm / P. Brut: 109 g  
Ø2.09 x 1.65" / G.W: 0.24 lbs

Colisage: 40 p / Env. 5 kg  
Carton: 40 p / Approx. 11.02 lbs

# SPEAKERBUDS

2-in-1 true wireless stereo earbuds + built-in Bluetooth® speaker  
 Écouteurs sans fil TWS 2-en-1 avec enceinte Bluetooth® intégrée

# SPEAKERBUDS

Design by Alain Bertheau

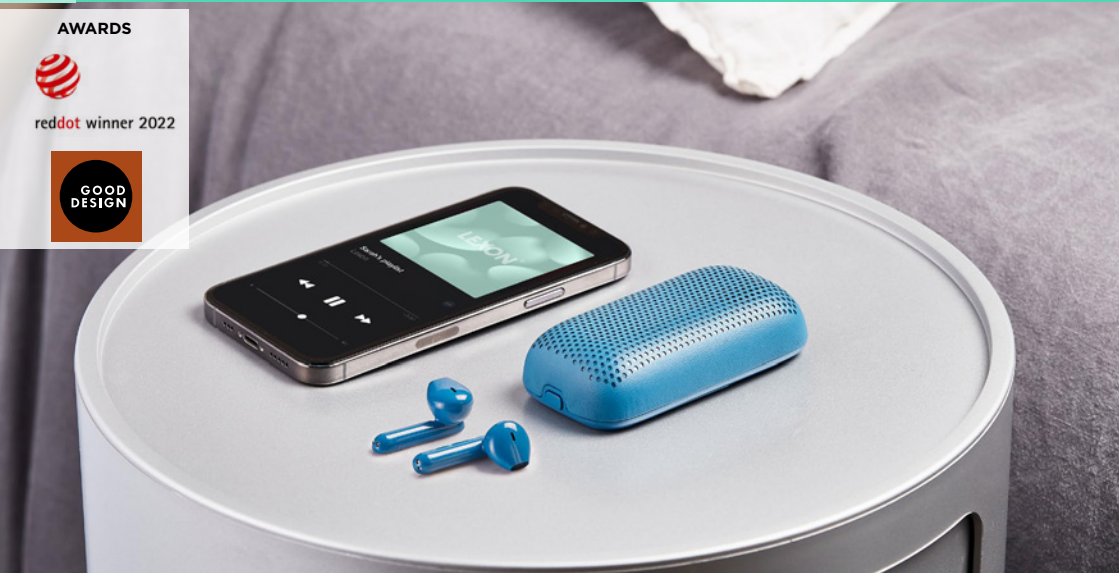

- ÉCOUTEURS SANS FIL TWS
- ENCEINTE PORTABLE
- DOUBLE MICROPHONE
- RÉDUCTION DU BRUIT AMBIANT
- JUSQU'À 24 H D'AUTONOMIE
- RECHARGEABLE PAR USB-C
- FINITION CUIR SYNTHÉTIQUE

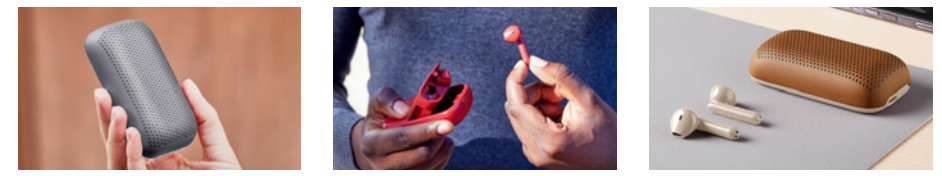

Écouteurs sans fil TWS 2-en-1 avec enceinte Bluetooth® intégrée - Double Microphone - Appels mains libres - Commandes vocales - Jusqu'à 6h de lecture musicale sur les écouteurs et 18h supplémentaires avec son étui de recharge - Rechargeable via USB-C (câble inclus). Matériaux : ABS enveloppé de cuir synthétique.

2-in-1 True Wireless Stereo Earbuds with Bluetooth® speaker - Dual Microphone - Hands-free calls - Voice commands - Up to 6h music playtime on buds and an extra 18h with its charging case - Rechargeable via USB-C port (cable included). Material: ABS wrapped with synthetic leather.

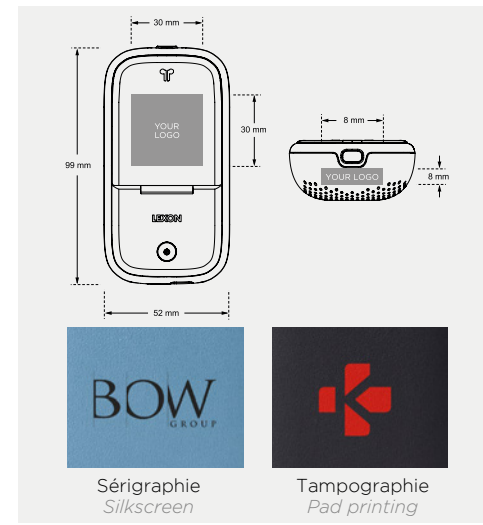

9.9 x 5.2 x 2.5 cm I.P.Brut: 120 g  
 3.89 x 2.05 x 0.98" | G.W : 0.26 lbs

Colisage: 40p / 7 kg  
 Carton : 40p / 15.42 lbs

# TYKHO 3

FM radio & Bluetooth® speaker / Radio FM & enceinte Bluetooth®

# TYKHO 3

Design by Marc Berthier



AWARD



RADIO FM  
FM RADIO

ENCEINTE BLUETOOTH  
BLUETOOTH SPEAKER

20 HEURES D'AUTONOMIE  
20 HOURS PLAYTIME

RECHARGEABLE PAR USB-C  
RECHARGEABLE VIA USB-C

RÉSISTE AUX ÉCLABOUSSURES  
RÉSISTE AUX ÉCLABOUSSURES

Radio FM - Enceinte Bluetooth® - Résiste aux projections d'eau - Plage de fréquence : FM 88-108MHz - Portée Bluetooth® : 10m - Autonomie : 20h - Temps de charge : 4h - Rechargeable par USB-C (câble inclus) - Matériaux : Gomme siliconée.

FM radio - Bluetooth® speaker - Splash-proof - Frequency range: FM 88-108MHz - Bluetooth® range: 10m - Battery life: 20h - Charging time: 4h - Rechargeable via USB-C port (cable included) - Material: Silicone rubber case.

MATT



D1 W9 R4 P4 O1

SOFT



V2 LB1 LL K9 M1



DB9 B9 G3 N1 J8

New colors / Nouvelles couleurs

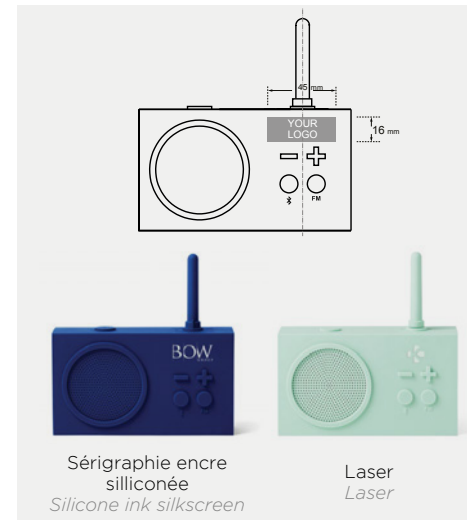

14 x 4,5 x 8,1 cm | P.Brut: 388 g  
5.51 x 1.77 x 3.19" | G.W: 0.85 lbs







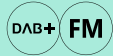

Colisage : 20p / 10.95 kg  
Carton : 20p / 24.14 lbs

# OSLO NEWS PREMIUM

DAB & FM alarm clock radio / Bluetooth® speaker / Wireless charger  
Radio-réveil DAB & FM / Enceinte Bluetooth® / Chargeur à induction



<p><b>RADIO RÉVEIL DAB + FM</b></p>  <p>DAB + FM ALARM CLOCK RADIO</p>	<p><b>ENCEINTE BLUETOOTH</b></p>  <p>BLUETOOTH SPEAKER</p>	<p><b>ÉCRAN COULEUR</b></p>  <p>COLOR SCREEN</p>	<p><b>STATION DE CHARGE SANS FIL 10W</b></p>  <p>WIRELESS CHARGING STATION 10W</p>	<p><b>CERTIFIÉ Qi</b></p>  <p>Qi CERTIFIED</p>	<p><b>RECHARGEABLE PAR USB-C</b></p>  <p>RECHARGEABLE VIA USB-C</p>
--	---	---	---	---	--



# OSLO NEWS PREMIUM

Design by Manuela Simonelli & Andrea Quaglio



Réveil radio DAB/FM avec solution de charge par induction - Enceinte Bluetooth - Écran couleur - fonctionne avec tous les appareils compatibles Qi - Alimenté par un connecteur USB-C (non inclus) - par USB-C (câble inclus) - Matériaux : Cuir synthétique - ABS.

*DAB Radio Bedside alarm clock with Qi wireless charging - Bluetooth speaker and FM Radio compatible - Operated with front color screen - Compatible with any Qi devices - Powered with USB-C connector (not included) - via USB-C (cable included) - Material: Synthetic leather - ABS.*

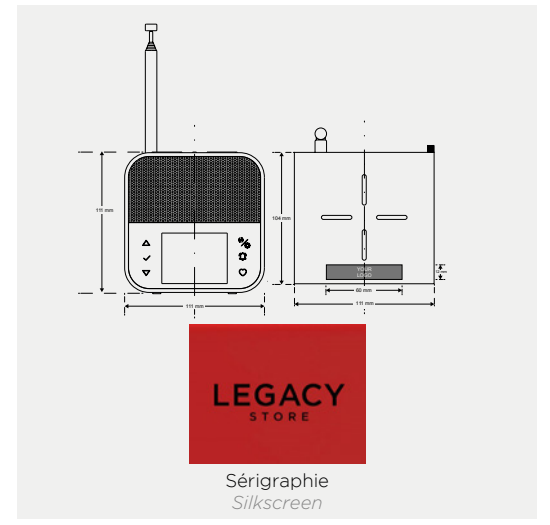

11.1 x 10.44 x 11.3 cm / P. Brut: 800 g  
4.37 x 4.11 x 4.45" / G.W: 1.76 lbs

Colisage : 12p / Env. 8.5 kg  
Carton: 12p / Approx. 19 lbs

# RAY SPEAKER

Set of magnetic Bluetooth® speakers / Duo d'enceintes Bluetooth® magnétiques

# RAY SPEAKER

Design by neil poulton



**AWARDS**

reddot winner 2024

DESIGN AWARD 2024



Duo d'enceintes Bluetooth® magnétiques - Compatible TWS pour une expérience stéréo - Résistante à l'eau (IPX4) - Autonomie : Jusqu'à 6h - Rechargeable par USB-C (câble inclus) - Temps de charge : 2h - Matériaux: Aluminium - Métal magnétique - ABS - Silicone.

Set of magnetic Bluetooth® speakers - TWS compatible for a stereo experience - Water resistant (IPX4) - Battery life: up to 6h - Rechargeable via USB-C (cable included) - Charge time: 2h - Material: Aluminum - Magnetic metal - ABS - Silicon.

<p><b>SET D'ENCEINTES BLUETOOTH</b></p> <p>BLUETOOTH SPEAKER SET</p>	<p><b>APPAIRABLE PAR TWS</b></p> <p>PAIRABLE VIA TWS</p>	<p><b>FIXATION MAGNÉTIQUE</b></p> <p>MAGNETIC ATTACHMENT</p>	<p><b>RECHARGEABLE PAR USB-C</b></p> <p>RECHARGEABLE VIA USB-C</p>	<p><b>ADAPTÉE À UN USAGE EXTÉRIEUR (IPX4)</b></p> <p>SUITABLE FOR OUTDOOR USE (IPX4)</p>	<p><b>FINITION ALUMINIUM</b></p> <p>ALUMINUM FINISHING</p>
--	--	--	--	--	--

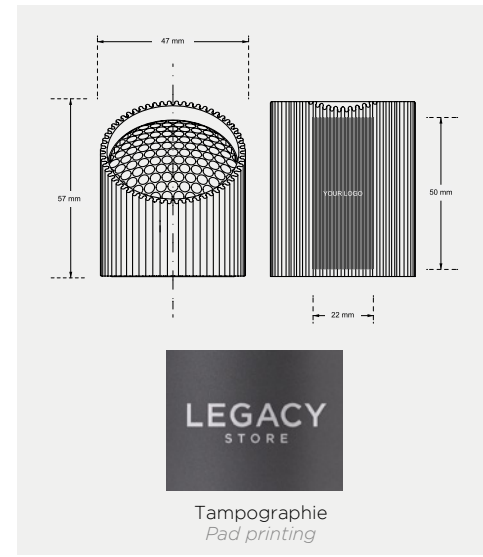

Ø4.7 x 5.7 cm / P. Brut: 272 g  
Ø1.85 x 2.2" / G.W: 0.61 lbs

Colisage: 40 p / Env. 12 kg  
Carton: 40 p / Approx. 26.45 lbs

# CONIC SPEAKER

360° Bluetooth® speaker / Enceinte Bluetooth® 360°

# CONIC SPEAKER

Design by Lidia Gomez



<p><b>ENCEINTE BLUETOOTH</b></p> <p>BLUETOOTH SPEAKER</p>	<p><b>SON 360°</b></p> <p>360° SOUND</p>	<p><b>APPARIBALE PAR TWS</b></p> <p>PAIRABLE VIA TWS</p>	<p><b>BOUTONS POUR LES COMMANDES AUDIO</b></p> <p>BUTTONS FOR AUDIO CONTROLS</p>	<p><b>RECHARGEABLE PAR USB-C</b></p> <p>RECHARGEABLE VIA USB-C</p>	<p><b>ADAPTÉE À UN USAGE EXTÉRIEUR (IPX4)</b></p> <p>SUITABLE FOR OUTDOOR USE (IPX4)</p>	<p><b>BASE EN ALUMINIUM</b></p> <p>ALUMINUM BASE</p>
---	--	--	--	--	--	--

Enceinte Bluetooth® 360° - Configuration audio composée de 2 haut-parleurs actifs et 1 haut-parleur de basse - Boutons pour les commandes audio et ajustement du volume - Compatible TWS pour une expérience stéréo - Autonomie : Jusqu'à 12h - Rechargeable par USB-C (câble inclus) - Temps de charge : 4h - Matériaux: Aluminium - Tissu - ABS.

360° Bluetooth® speaker - Audio configuration featuring 2 active drivers and 1 passive driver - Buttons for audio controls and volume adjustment - TWS compatible for a stereo experience - Battery life: Up to 12h - Rechargeable via USB-C (cable included) - Charging time: 4h - Material: Aluminum - Fabric - ABS.

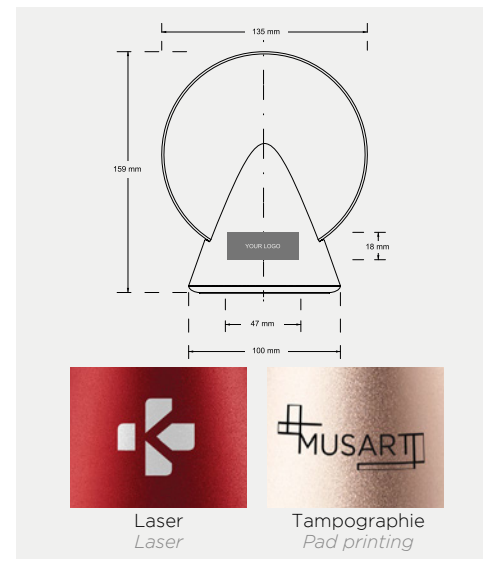

Ø13,5 x 15,9 cm / P. Brut: 800 g  
Ø5.31 x 6.26" / G.W: 1.76 lbs

Colisage: 12 pcs / Env.12 kg  
Carton: 12 pcs / Approx. 26.45 lbs

**ILLUMINATE**  
ÉCLAIRER



**ILLUMINATE** ÉCLAIRER



**MINA**  
**COLLECTION**

**NEW**

**LUMA**  
**COLLECTION**

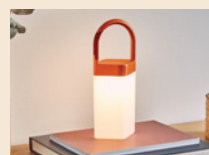

**HORIZON**  
**HANGING**  
**LAMP**

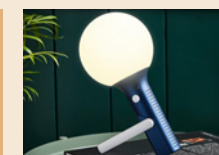

**BOLLA+**

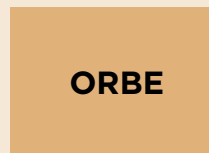

**ORBE**

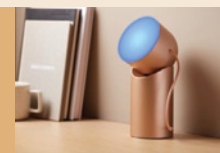

**BUBBLE**  
**LAMP**

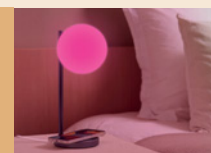

**LANTERN**

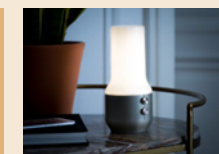

**TERRACE+**

**NEW**

**STELI**



**NEW**

**RAY LIGHT**

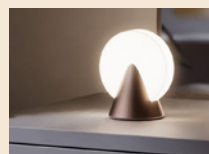

**CONIC**  
**LAMP**

**NEW**



**CITY LIGHT**  
**PRO**

**NEW**

**NEW**

**MIMI**



**NEW**

**HELIA**



# MINA

Mini LED lamp (3 inches) / Mini lampe LED (8 cm)

# MINA

Design by Manuela Simonelli & Andrea Quaglio

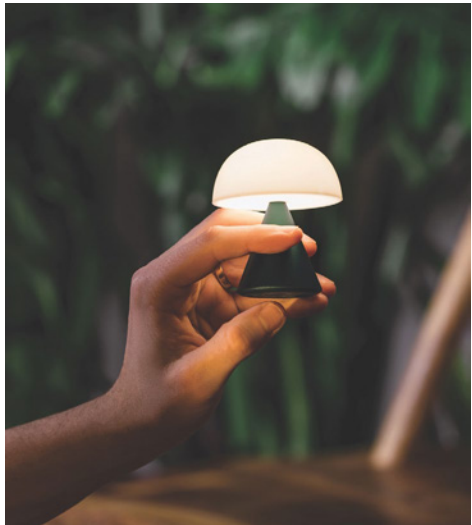

LUMIÈRE BLANCHE CHAUDE OU FROIDE



WARM OR COLD WHITE LIGHT

VARIATEUR D'INTENSITÉ



DIMMER

JUSQU'À 12 HEURES D'AUTONOMIE



UP TO 12 HOURS BATTERY LIFE

RECHARGEABLE PAR USB-C



RECHARGEABLE VIA USB-C

FINITION ALUMINIUM



ALUMINIUM FINISHING

Mini Lampe LED - Lumière blanche froide ou chaude - Puissance lumineuse maximale : 20 lm - Variateur d'intensité à mémoire - Autonomie : jusqu'à 12h (testée à 75% de luminosité, 22°C de température ambiante) - Temps de charge : 2h - Rechargeable par USB-C (câble inclus). Matériaux : Aluminium - ABS.

Mini LED lamp - Cool or warm white light - Maximum light output: 20 lm - Memory dimmer - Battery life: up to 12h (tested at 75% brightness, 22°C ambient indoor temperature) - Charging time: 2h - Rechargeable via USB-C (cable included). Material: Aluminum - ABS.

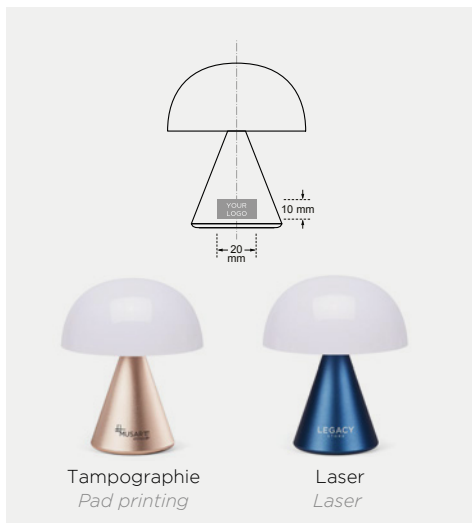

Ø 7 x 8,3 cm | P.Brut : 165g  
Ø2.76 x 3.27" | G.W : 0.36 lbs

Colisage: 40p / 8,2 kg  
Carton : 40p / 18 lbs

# MINA M

Medium portable LED lamp (4 inches) / Lampe LED portable medium (11 cm)

# MINA M

Design by Manuela Simonelli & Andrea Quaglio

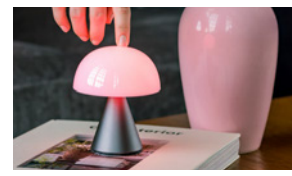

- LAMPE AVEC 9 COULEURS DE LED**  
LAMP WITH 9 LED COLORS
- VARIATEUR D'INTENSITÉ**  
DIMMER
- JUSQU'À 24 HEURES D'AUTONOMIE**  
UP TO 24 HOURS BATTERY LIFE
- PORT DE CHARGE USB-C**  
USB-C CHARGING PORT
- RECHARGEABLE PAR INDUCTION**  
WIRELESSLY RECHARGEABLE
- ADAPTÉE À UN USAGE EXTÉRIEUR (IPX4)**  
SUITABLE FOR OUTDOOR USE (IPX4)
- FINITION ALUMINIUM**  
ALUMINIUM FINISHING

Lampe LED portable medium - Lumière blanche froide ou chaude +7 couleurs - Puissance lumineuse maximale : 40 lm - Contrôle de la lumière par pression - Variateur d'intensité - Résistance à l'eau IPX4 - Autonomie : jusqu'à 24h (testée à 75% de luminosité, 22°C de température ambiante) - Temps de charge : 2h - Rechargeable par USB-C (câble inclus) ou par induction - Matériaux : Aluminium - ABS.

Medium portable LED lamp - Cool or warm white light +7 colors - Maximum light output: 40 lm - Push activation light - Dimmer - Water resistant IPX4 - Battery life: up to 24h (tested at 75% brightness, 22°C ambient indoor temperature) - Charging time: 2h - Rechargeable via USB-C (cable included) or wirelessly - Material: Aluminum - ABS.



Ø9,2 x 11 cm | P. Brut : 350 g  
Ø3.62 x 4.33" | G.W. : 0.77 lbs

Colisage: 40p / 13,2 kg  
Carton : 40p / 29 lbs

# MINA L

Large portable LED lamp (7 inches) / Lampe LED portable large (17 cm)

# MINA L

Design by Manuela Simonelli & Andrea Quaglio

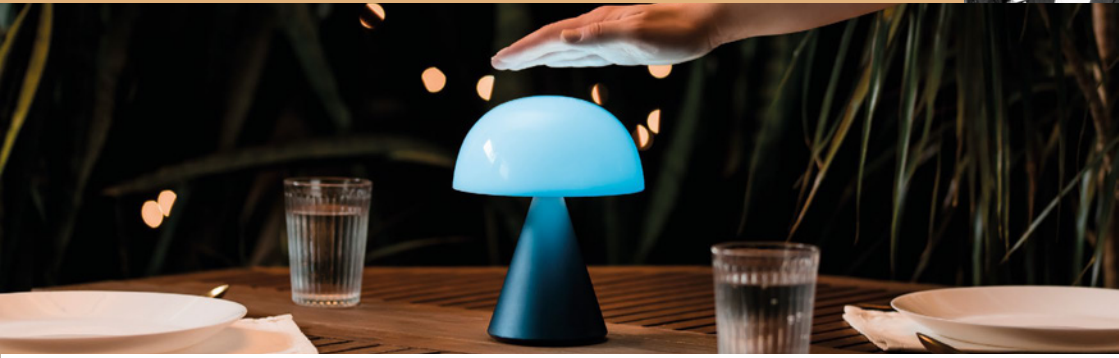

- LAMPE AVEC 9 COULEURS DE LED**

LAMP WITH 9 COLORS
- VARIATEUR D'INTENSITÉ**

DIMMER
- JUSQU'À 24 HEURES D'AUTONOMIE**

UP TO 24 HOURS BATTERY LIFE
- PORT DE CHARGE USB-C**

USB-C CHARGING PORT
- RECHARGEABLE PAR INDUCTION**

WIRELESSLY RECHARGEABLE
- ADAPTÉE À UN USAGE EXTÉRIEUR (IPX4)**

SUITABLE FOR OUTDOOR USE (IPX4)
- FINITION ALUMINIUM**

ALUMINUM FINISHING



Lampe LED portable large - Lumière blanche froide ou chaude + 7 couleurs - Puissance lumineuse maximale : 65 lm - Contrôle de la lumière par pression - Variateur d'intensité - Résistance à l'eau IPX4 - Autonomie : jusqu'à 24h (testée à 75% de luminosité, 22°C de température ambiante) - Temps de charge : 3h - Rechargeable par USB-C (câble inclus) ou par induction. Matériaux : Aluminium - ABS.

Large portable LED lamp - Cool or warm white light + 7 colors - Maximum light output: 65 lm - Push activation light - Dimmer - Water resistant IPX4 - Battery life: up to 24h (tested at 75% brightness, 22°C ambient indoor temperature) - Charging time: 3h - Rechargeable via USB-C (cable included) or wirelessly - Material: Aluminum - ABS.

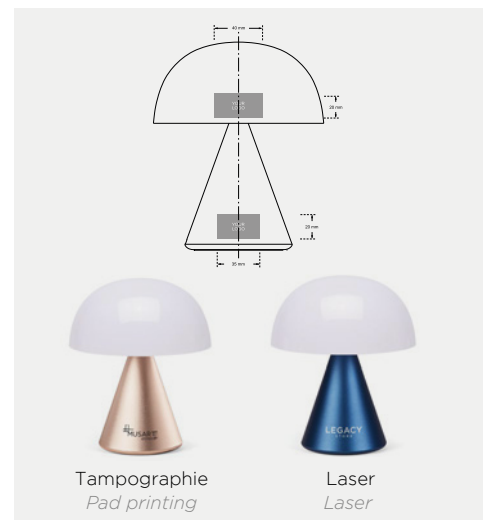

Ø14 x 17 cm | P.Brut : 600 g  
5.5 x 6.73" | P.Brut : 1.33 lbs



Colisage : 12p / 8,0 kg  
Carton : 12p / 17,64 lbs

# MINA L AUDIO

Portable LED lamp with 360° built-in Bluetooth® speaker  
Lampe LED portable avec enceinte Bluetooth® à 360° intégrée

# MINA L AUDIO

Design by Manuela Simonelli & Andrea Quaglio



**AWARDS**

reddot winner 2022

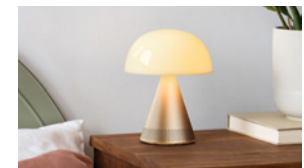
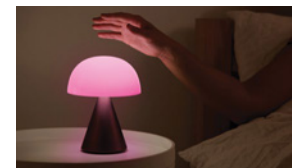
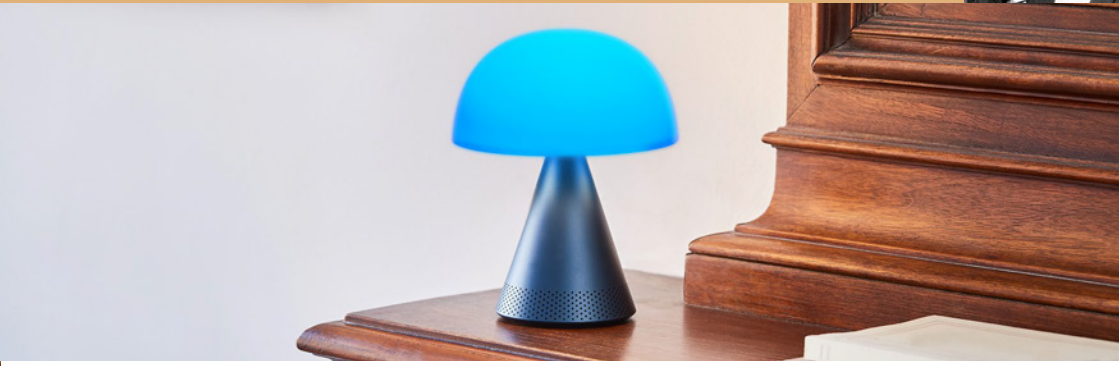

- LAMPE AVEC 9 COULEURS DE LED**  
 LAMP WITH 9 LED COLORS
- ENCEINTE BLUETOOTH®**  
 BLUETOOTH SPEAKER
- SON 360°**  
 360° SOUND
- VARIATEUR D'INTENSITE**  
 DIMMER
- JUSQU'À 24 HEURES D'AUTONOMIE**  
 UP TO 24 HOURS BATTERY LIFE
- PORT DE CHARGE USB-C**  
 USB-C CHARGING PORT
- RECHARGEABLE PAR INDUCTION**  
 WIRELESSLY RECHARGEABLE
- FINITION ALUMINIUM**  
 ALUMINIUM FINISHING

Lampe LED audio portable large - Lumière blanche froide ou chaude + 7 couleurs - Puissance lumineuse maximale : 65 lm - Contrôle de la lumière par pression - Variateur d'intensité - Enceinte Bluetooth® 5W - Autonomie d'éclairage : jusqu'à 24h (testée à 75% de luminosité, 22°C de température ambiante) - Temps de charge : 3h - Rechargeable par USB-C (câble inclus) ou par induction - Matériaux : Aluminium - ABS.

Large portable audio LED lamp - Cool or warm white light + 7 colors - Maximum light output: 65 lm - Push activation light - Dimmer - Light battery life: up to 24h (tested at 75% brightness, 22°C ambient indoor temperature) Charging time: 3h - Rechargeable via USB-C (cable included) or wirelessly. Material: Aluminium - ABS.



Tampographie  
Pad printing

Laser  
Laser



Ø14 x 17 cm | P.Brut : 614 g  
Ø5.5 x 6.7" | G.W. : 1.35 lbs

Colisage: 12p / 8,4 kg  
Carton : 12p / 18.52 lbs

# LUMA S

Infinitely synchronizable LED lamp (3 inches)  
Lampe LED synchronisable à l'infini (8 cm)



- LAMPE AVEC 9 COULEURS DE LED**  
LAMP WITH 9 LED COLORS
- CONNECTABLE À L'INFINI**  
INFINITELY PAIRABLE
- VARIATEUR D'INTENSITÉ**  
DIMMER
- JUSQU'À 12 H D'AUTONOMIE**  
UP TO 12 H BATTERY LIFE
- PORT DE CHARGE USB-C**  
USB-C CHARGING PORT
- ADAPTÉE À UN USAGE EXTÉRIEUR (IPX4)**  
SUITABLE FOR OUTDOOR USE (IPX4)
- FINITION ALUMINIUM**  
ALUMINIUM FINISHING

# LUMA S

Design by Manuela Simonelli & Andrea Quaglio



Lampe LED synchronisable à l'infini - Lumière blanche froide ou chaude + 7 couleurs - Puissance lumineuse maximale : 30 lm - Variateur d'intensité - Contrôle tactile - Résistante à l'eau (IPX4) - Autonomie : Jusqu'à 12h (testée à 75% de luminosité) - Rechargeable par USB-C (câble inclus) - Temps de charge : 2h - Matériaux : Aluminium - ABS.

Infinitely synchronizable LED lamp - Cool or warm white light + 7 colors - Maximum light output: 30 lm - Dimmer - Touch control - Water resistant (IPX4) - Battery life: Up to 12h (tested at 75% brightness) - Rechargeable via USB-C (cable included) - Charge time: 2h - Material: Aluminum - ABS.

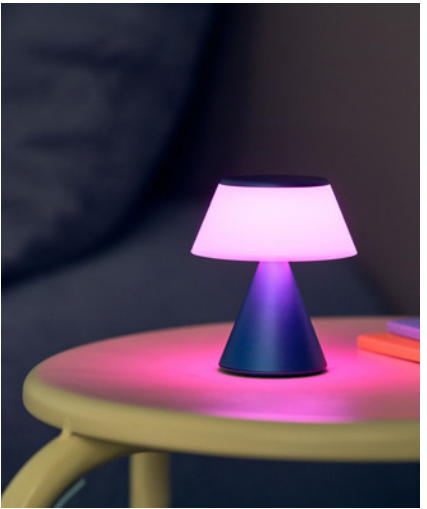
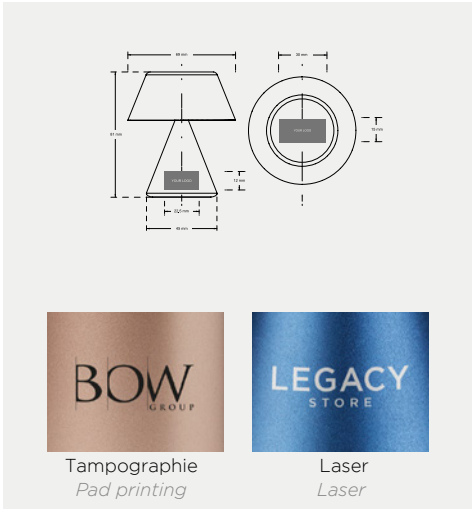

Ø6.9 x 8.1 cm / P. Brut: 140 g  
Ø2.72 x 3.19" / G.W: 0.31 lbs

Colisage: 40 p / Env. 7.6 kg  
Carton: 40 p / Approx. 16.76 lbs

# LUMA M

Infinitely synchronizable LED lamp (4 inches)  
Lampe LED synchronisable à l'infini (11 cm)



- LAMPE AVEC 9 COULEURS DE LED**  
LAMP WITH 9 LED COLORS
- CONNECTABLE À L'INFINI**  
INFINITELY PAIRABLE
- VARIATEUR D'INTENSITÉ**  
DIMMER
- JUSQU'À 12 H D'AUTONOMIE**  
UP TO 12 H BATTERY LIFE
- PORT DE CHARGE USB-C**  
USB-C CHARGING PORT
- RECHARGEABLE PAR INDUCTION**  
WIRELESSLY RECHARGEABLE
- ADAPTÉE À UN USAGE EXTÉRIEUR (IPX4)**  
SUITABLE FOR OUTDOOR USE (IPX4)
- FINITION ALUMINIUM**  
ALUMINUM FINISHING

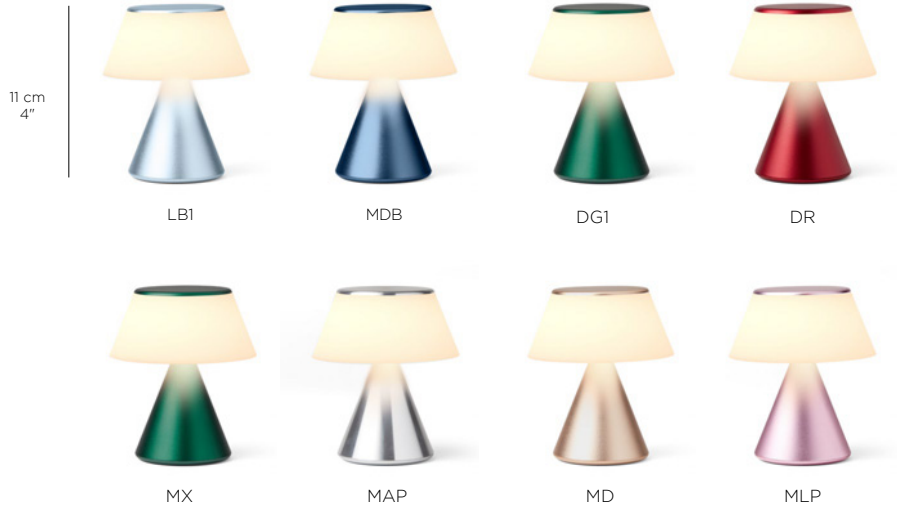

# LUMA M

Design by Manuela Simonelli & Andrea Quaglio



Lampe LED synchronisable à l'infini - Lumière blanche froide ou chaude + 7 couleurs - Puissance lumineuse maximale : 45 lm - Variateur d'intensité - Contrôle tactile - Résistante à l'eau (IPX4) - Autonomie : Jusqu'à 12h (testée à 75% de luminosité) - Rechargeable par USB-C (câble inclus) ou par induction - Temps de charge : 3h - Matériaux: Aluminium - ABS.

*Infinitely Synchronizable LED lamp - Cool or warm white light + 7 colors - Maximum light output: 45 lm - Dimmer - Touch control - Water resistant (IPX4) - Battery life: Up to 12h (tested at 75% brightness) - Rechargeable via USB-C (cable included) or wirelessly - Charge time: 3h - Material: Aluminum - ABS.*

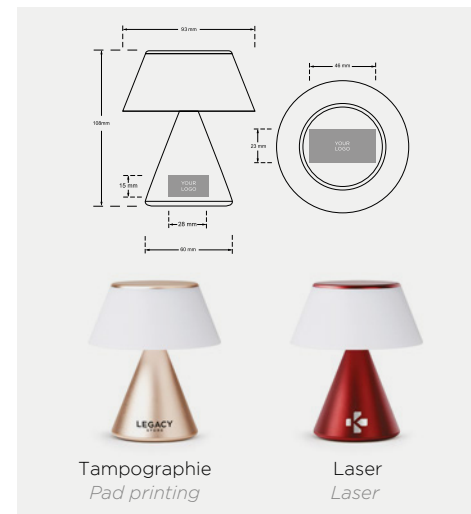

Ø9,3 x 10,8 cm - P.Brut : 281 g  
Ø3.66 x 4.25" - G.W: 0.62 lbs



Colisage : 20p / 6.1 kg  
Carton: 20p / 13.45 lbs

# LUMA L

Infinitely synchronizable LED lamp (7 inches)  
Lampe LED synchronisable à l'infini (18 cm)



- LAMPE AVEC 9 COULEURS DE LED**  
LAMP WITH 9 LED COLORS
- 120 LUMENS DE LUMINOSITÉ**  
120 LUMENS BRIGHTNESS
- CONNECTABLE À L'INFINI**  
INFINITELY PAIRABLE
- VARIATEUR D'INTENSITÉ**  
DIMMER
- JUSQU'À 12 H D'AUTONOMIE**  
UP TO 12 H BATTERY LIFE
- PORT DE CHARGE USB-C**  
USB-C CHARGING PORT
- RECHARGEABLE PAR INDUCTION**  
WIRELESSLY RECHARGEABLE
- ADAPTÉE À UN USAGE EXTÉRIEUR (IPX4)**  
SUITABLE FOR OUTDOOR USE (IPX4)
- FINITION ALUMINIUM**  
ALUMINIUM FINISHING



Colors on request / Couleurs sur demande

# LUMA L

Design by Manuela Simonelli & Andrea Quaglio



Lampe LED synchronisable à l'infini - Lumière blanche froide ou chaude + 7 couleurs - Puissance lumineuse maximale : 150 lm - Variateur d'intensité - Contrôle tactile - Résistante à l'eau (IPX4) - Autonomie : Jusqu'à 12h (testée à 75% de luminosité) - Rechargeable par USB-C (câble inclus) ou par induction - Temps de charge : 4h - Matériaux: Aluminium - ABS.

Infinitely synchronizable LED lamp - Cool or warm white light + 7 colors - Maximum light output: 150 lm - Dimmer - Touch control - Water resistant (IPX4) - Battery life: Up to 12h (tested at 75% brightness) - Rechargeable via USB-C (cable included) or wirelessly - Charge time: 4h - Material: Aluminum - ABS.

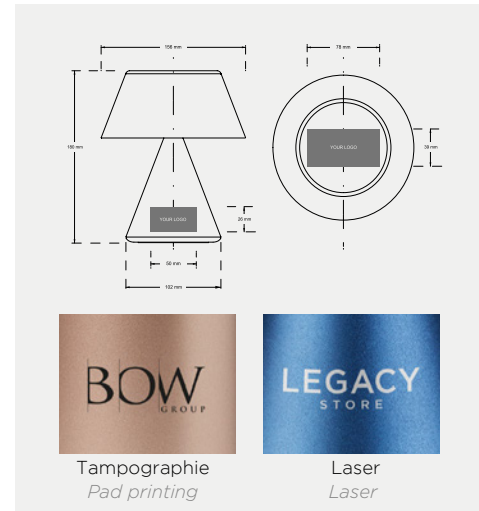

Ø15.6 x 18 cm / P. Brut: 720 g  
Ø6.14 x 7" / G.W: 1.59 lbs



Colisage: 12 p / Env. 11.2 kg  
Carton: 12 p / Approx. 24.69 lbs

# LUMA XL

Infinitely synchronizable LED lamp (12 inches)  
Lampe LED synchronisable à l'infini (25 cm)



- LAMPE AVEC 9 COULEURS DE LED
- 200 LUMENS DE LUMINOSITÉ
- CONNECTABLE À L'INFINI
- VARIATEUR D'INTENSITÉ
- JUSQU'À 12 H D'AUTONOMIE
- PORT DE CHARGE USB-C
- RECHARGEABLE PAR INDUCTION
- ADAPTÉE À UN USAGE EXTÉRIEUR (IPX4)
- FINITION ALUMINIUM



Colors on request / Couleurs sur demande

# LUMA XL

Design by Manuela Simonelli & Andrea Quaglio

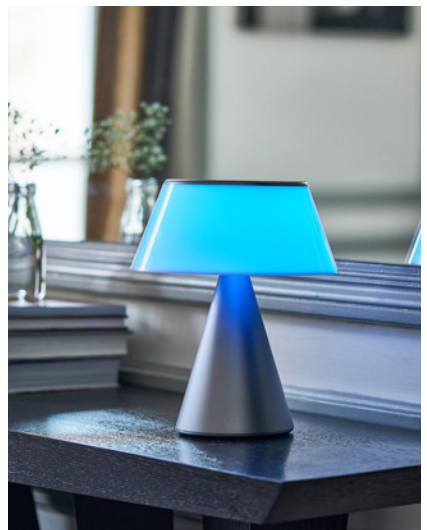

Lampe LED synchronisable à l'infini - Lumière blanche froide ou chaude + 7 couleurs - Puissance lumineuse maximale : 200 lm - Variateur d'intensité - Contrôle tactile - Résistante à l'eau (IPX4) - Autonomie : Jusqu'à 12h (testée à 75% de luminosité) - Rechargeable par USB-C (câble inclus) ou par induction - Temps de charge : 4h - Matériaux: Aluminium - ABS.

Infinitely synchronizable LED lamp - Cool or warm white light + 7 colors - Maximum light output: 200 lm - Dimmer - Touch control - Water resistant (IPX4) - Battery life: Up to 12h (tested at 75% brightness) - Rechargeable via USB-C (cable included) or wirelessly - Charge time: 4h - Material: Aluminum - ABS.

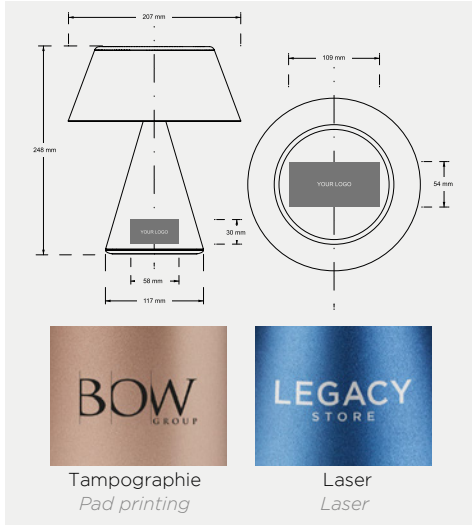

Ø20.7 x 24.8 cm / P. Brut: 1280 g  
Ø8.15 x 9.7" / G.W: 2.82 lbs



Colisage: 4 p / Env. 7.3 kg  
Carton: 4 p / Approx. 16.09 lbs

# HORIZON HANGING LAMP

Multi-color outdoor LED lamp / Lampe portable d'extérieur à LED multicolore



- LAMPE AVEC 9 COULEURS DE LED**  
 LAMP WITH 9 LED COLORS
- VARIATEUR D'INTENSITÉ**  
 DIMMER
- CONTRÔLE TACTILE**  
 TOUCH CONTROLS
- JUSQU'À 12 HEURES D'AUTONOMIE**  
 UP TO 12 HOURS BATTERY LIFE
- RECHARGEABLE PAR USB-C**  
 RECHARGEABLE VIA USB-C
- ADAPTÉE À UN USAGE EXTÉRIEUR (IPX4)**  
 SUITABLE FOR OUTDOOR USE (IPX4)
- POIGNÉE EN ALUMINIUM**  
 ALUMINIUM HANDLE

22.9 cm  
8.66"



D O1 LB1 X

# HORIZON HANGING LAMP

Design by natacha.sacha.



Lampe LED nomade avec poignée - Lumière blanche froide ou chaude + 7 couleurs d'éclairage - Puissance lumineuse maximale : 65 lm - Contrôles tactiles - Variateur d'intensité - Résistance à l'eau IPX4 - Autonomie : jusqu'à 12h - Temps de charge : 3h - Rechargeable via USB-C (câble inclus). Matériaux : Aluminium - ABS.

*Hanging portable LED lamp - Cool or warm white light + 7 colors - Maximum light output: 65 lm - Touch activation light - Dimmer - Water resistant IPX4 - Battery life: up to 12h - Charging time: 3h - Rechargeable via USB-C port (cable included). Material: Aluminum - ABS.*

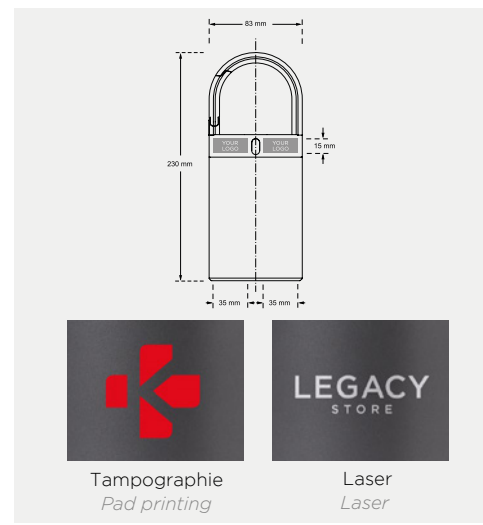

9.4 x 7 x 22.9 cm | P. Brut : 350 g  
3.54 x 2.75 x 8.66" | G.W: 0.77 lbs



Colisage : 12 p / 6.2 kg  
Carton: 12 p / 13.66 lbs

# BOLLA+

Multi-color outdoor LED lamp / Lampe portable d'extérieur à LED multicolore



LAMPE AVEC 9 COULEURS DE LED



LAMP WITH 9 LED COLORS

VARIATEUR D'INTENSITÉ



DIMMER

JUSQU'À 8 H D'AUTONOMIE



UP TO 8 H BATTERY LIFE

RECHARGEABLE PAR USB-C



RECHARGEABLE VIA USB-C

ADAPTÉE À UN USAGE EXTÉRIEUR (IPX4)



SUITABLE FOR OUTDOOR USE (IPX4)



DB9

N

D9

X9

W

# BOLLA+

Design by Claudio Gatto



Lampe LED multiposition - Usage intérieur/extérieur - Lumière blanche froide ou chaude + 7 couleurs - Puissance lumineuse maximale : 25 lm - Contrôle tactile - Mémoire de sauvegarde de la dernière couleur sélectionnée - Autonomie : jusqu'à 8h - Temps de charge : 2h - Rechargeable par USB-C (câble inclus) - Résistance à l'eau : IPX4 - Matériaux : Silicone - ABS.

Multi-position LED lamp - Indoor/outdoor use - Cool or warm white light + 7 colors - Maximum light output: 25 lm - Touch control - Backup memory of the last color selected - Battery life: up to 8h - Charging time: 2h Rechargeable via USB-C (cable included) - Water resistance: IPX4 .Material: Silicone - ABS.

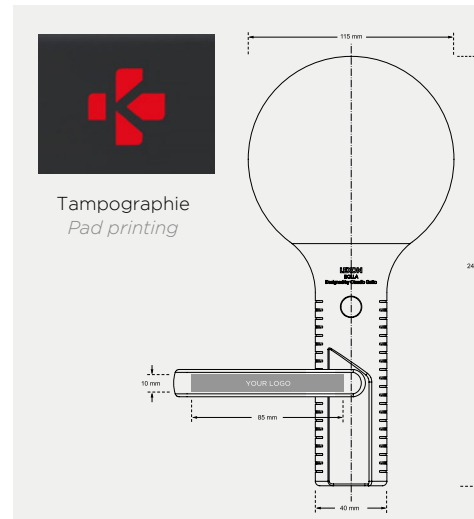

Ø11,5 x 28,2 cm | P. Brut : 318 g  
Ø4,5 x 11,1" | G.W : 0.7 lbs



Colisage : 20 p / 11.6 kg  
Carton : 20p / 25,5 lbs

# ORBE

Portable LED lamp with moving head / Lampe LED portable avec tête amovible

# ORBE

Design by Nelson Fossey



AWARDS



- LAMPE AVEC 9 COULEURS DE LED

LAMP WITH 9 LED COLORS
- 100 LUMENS DE LUMINOSITÉ

100 LUMENS BRIGHTNESS
- TÊTE MAGNÉTIQUE ROTATIVE & DÉTACHABLE

ROTATING & DETACHABLE MAGNETIC HEAD
- VARIATEUR D'INTENSITÉ

DIMMER
- JUSQU'À 48 H D'AUTONOMIE

UP TO 48 H BATTERY LIFE
- RECHARGEABLE PAR USB-C

RECHARGEABLE VIA USB-C
- ADAPTÉE À UN USAGE EXTÉRIEUR (IPX4)

SUITABLE FOR OUTDOOR USE (IPX4)

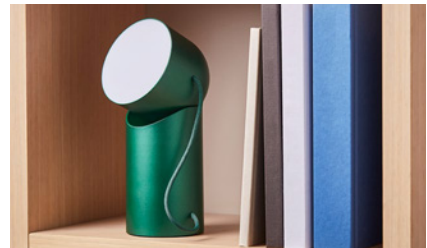
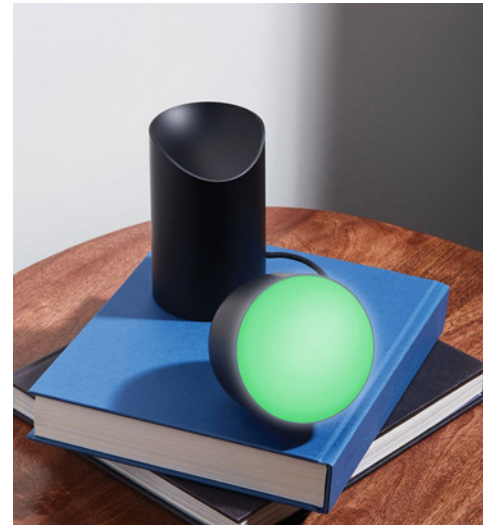

Lampe LED portable avec tête rotative et amovible - 9 couleurs d'éclairage - Puissance lumineuse maximale : 100 lm - Variateur d'intensité - Jusqu'à 48 heures d'éclairage - Temps de charge : 5h - Rechargeable par USB-C - Convient pour une utilisation en extérieur (IPX4) - Matériaux : ABS - PP.

Portable LED lamp with moving and detachable head - 9 LED colors - Maximum light output: 100 lm - Dimmer - Up to 48 hours of illumination - Charging time: 5h - Rechargeable via USB-C - Suitable for outdoor use (IPX4). Material: PP - ABS.

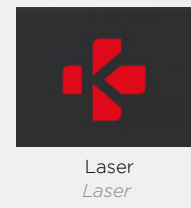
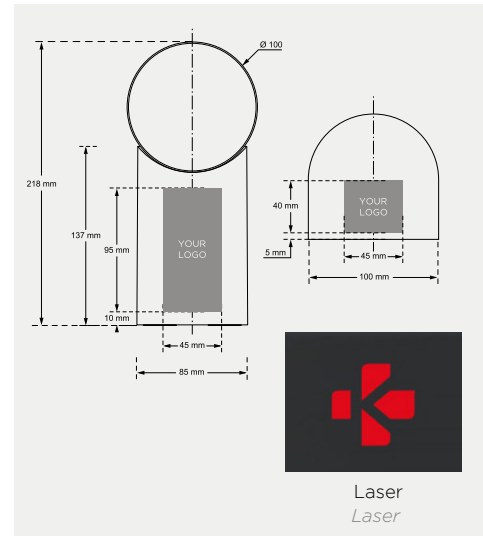

Ø10 x 21,8 cm - P.Brut : 800 g  
Ø3.94 x 8.27"- G.W: 11.76 lbs



Colisage : 12p / 10.7 kg  
Carton: 12p / 23.6 lbs

# BUBBLE LAMP

Desk lamp with built-in wireless charger  
Lampe de bureau avec chargeur à induction intégré

# BUBBLE LAMP

Design by Alain Berteau

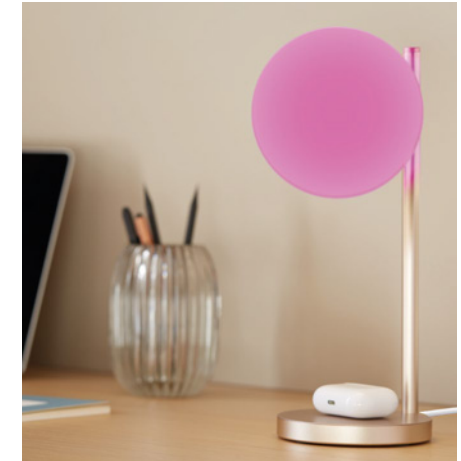

- LAMPE AVEC 9 COULEURS DE LED**  
 LAMP WITH 9 LED COLORS
- 150 LUMENS DE LUMINOSITÉ**  
 150 LUMENS BRIGHTNESS
- DIFFUSEUR EN VERRE OPALE**  
 FROSTED GLASS DIFFUSER
- VARIATEUR D'INTENSITÉ**  
 DIMMER
- CHARGEUR À INDUCTION RAPIDE 15W**  
 15W FAST WIRELESS CHARGER
- CERTIFIÉ Qi**  
 Qi CERTIFIED
- JUSQU'À 6 H D'AUTONOMIE**  
 UP TO 6 H BATTERY LIFE
- FINITION ALUMINIUM**  
 ALUMINIUM FINISHING

Lampe de bureau avec chargeur à induction intégré - Lumière blanche froide ou chaude + 7 couleurs d'éclairage - Puissance lumineuse maximale : 150 lm - Variateur d'intensité - Contrôle tactile - Compatible avec tous les appareils dotés de la technologie Qi - Autonomie : Jusqu'à 6h - Temps de charge : 3h - Double port USB-C pour charger et recharger - Matériaux : Aluminium - ABS - Verre.

Desk lamp with built-in wireless charger - Cold or warm white light + 7 lighting colors - Maximum light output: 150 lm - Dimmer - Touch control - Compatible with all Qi-enabled devices - Battery life: Up to 6 hours - Charging time: 3h - Dual USB-C port for charging and recharging. Material: Aluminum - ABS - Glass.

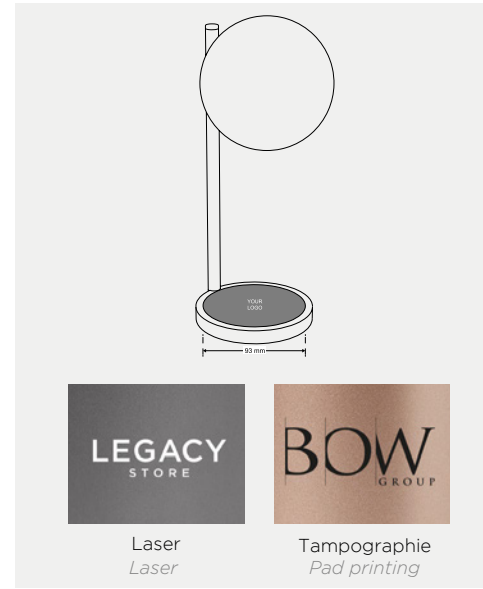

Ø4.72 x 11.69 cm - P.Brut : 813 g  
Ø29.7 x 11.4" - G.W: 1.79 lbs

Colisage : 8p / 8.1 kg  
Carton: 8p / 17.86 lbs









# LANTERN

Portable lamp with built-in wireless charger  
Lampe portable avec chargeur à induction intégré

**AWARDS**





-   
**LAMPE AVEC 9 COULEURS DE LED**  
 LAMP WITH 9 LED COLORS
-   
**100 LUMENS DE LUMINOSITÉ**  
 100 LUMENS BRIGHTNESS
-   
**VARIATEUR D'INTENSITÉ**  
 DIMMER
-   
**CONTRÔLE TACTILE**  
 TOUCH CONTROLS
-   
**BATTERIE EXTERNE 5 000 mAh**  
 5 000 mAh POWER BANK
-   
**CHARGEUR À INDUCTION**  
 WIRELESS CHARGER
-   
**JUSQU'À 8 H D'AUTONOMIE**  
 UP TO 8 H BATTERY LIFE
-   
**ADAPTÉE À UN USAGE EXTÉRIEUR (IPX4)**  
 SUITABLE FOR OUTDOOR USE (IPX4)



# LANTERN

Design by Alain Berteau



Un design contemporain pour un objet intemporel - Une solution d'éclairage LED élégante et contrôlée tactilement - Puissance lumineuse maximale : 100 lm - Un éclairage mobile intérieur et extérieur combiné à un chargeur par induction certifié Qi pour les appareils compatibles - Batterie intégrée de 5000 mAh et des LED RVB à 9 couleurs - Utilisable en extérieur classée IPX4 - Autonomie : 8h pour l'éclairage seul - Temps de charge: 4h - Connexion : USB-C (câble inclus) - Alimentation : il est recommandé d'utiliser l'adaptateur secteur Quick Charge 3.0 (non inclus) ou un adaptateur secteur DC 9 V/2 A (non inclus). Matériaux: Cuir synthétique - ABS.

*Contemporary design for a timeless object - Embedding elegant and touch-controlled LED lighting solution - Maximum light output: 100 lm - Offering outdoor and indoor mobile illumination combined with a Qi certified wireless charger for enabled devices - 5000 mAh built-in battery and 9 colors RGB LEDs - Outdoor friendly with IPX4 rating - Battery life: Up to 8h for lighting mode only - Charging time: 4h - Connection: USB-C (cable included) - Power supply: recommend to use with Quick Charge 3.0 Power Adapter (not included) or a DC 9V/2A power Adapter (not included). Material: Synthetic leather - ABS.*

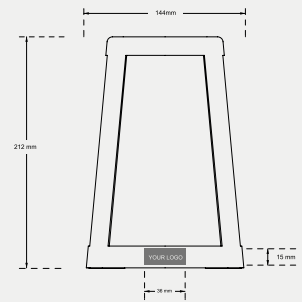

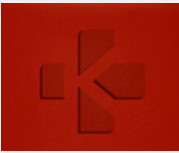

Laser  
Laser



Tampographie  
Pad printing

14.4 x 14.4 x 21.2 cm | P. Brut : 746 g  
5.6 x 5.6 x 8.3" | G.W: 1.64lbs



Colisage : 8p / 7.3 kg  
Carton: 8p / 16.09lbs

# TERRACE+

3-in-1 LED lamp with built-in speaker & power bank  
*Lampe LED 3-en-1 avec enceinte & batterie intégrées*

# TERRACE+

Design by Anne Klepper & Elise Berthier



Lampe LED 3-en-1 avec enceinte & batterie intégrées - Lumière blanche froide ou chaude + 9 programmes d'effets lumineux d'ambiance - Puissance lumineuse maximale : 150 lm - Variateur d'intensité - Contrôle tactile - Résistante à l'eau (IPX4) - Connecteur USB-C à double sens + port 2-USB A pour recharger n'importe quel appareil - Autonomie d'éclairage : jusqu'à 24h (testée à 75% de luminosité) - Rechargeable par USB-C (câble inclus) - Matériaux : Métal - ABS. Marquage conseillé : laser - tampographie.

3-In-1 LED lamp with built-in speaker & power bank - Cool or warm white light + 9 special lighting effects - Special lighting effect - Maximum light output: 150 lm - Dimmer - Touch control - Water-resistant (IPX4) - Two-way USB-C connector + 2-USB A port for recharging any device - Light battery life: up to 24h (tested at 75% brightness) - Rechargeable via USB-C (cable included) - Material: Metal - ABS. Suggested branding: laser - pad print.

- LAMPE AVEC 9 COULEURS DE LED**  
LAMP WITH 9 LED COLORS
- ENCEINTE BLUETOOTH**  
BLUETOOTH SPEAKER
- 150 LUMENS DE LUMINOSITÉ**  
150 LUMENS BRIGHTNESS
- SON 360°**  
360° SOUND
- VARIATEUR D'INTENSITÉ**  
DIMMER
- BATTERIE EXTERNE 4 000 mAh**  
4 000 mAh POWER BANK
- 2X PORTS USB-A POUR RECHARGER**  
2X USB-A PORTS TO RECHARGE
- PORT USB-C POUR CHARGER ET RECHARGER**  
TWO-WAY USB-C PORT TO RECHARGE
- ADAPTÉE À UN USAGE EXTÉRIEUR (IPX4)**  
SUITABLE FOR OUTDOOR USE (IPX4)

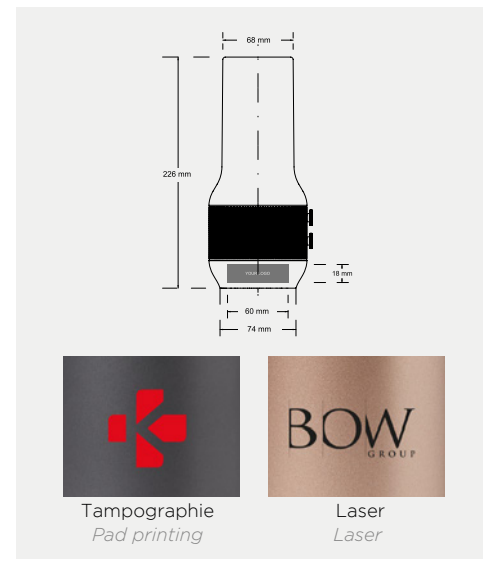

Ø10 x 22,6 cm / P. Brut : 705 g  
 Ø3.94 x 8.89" / G.W: 1.55 lbs

Colisage: 12 pcs / Env. 9.7 kg  
 Carton: 12 pcs / Approx. 21.38 lbs

Color on request / Couleur sur demande

# STELI

Infinitely synchronisable table lamp / Lampe de table synchronizable à l'infini

# STELI

Design by Manuela Simonelli & Andrea Quaglio



AWARD

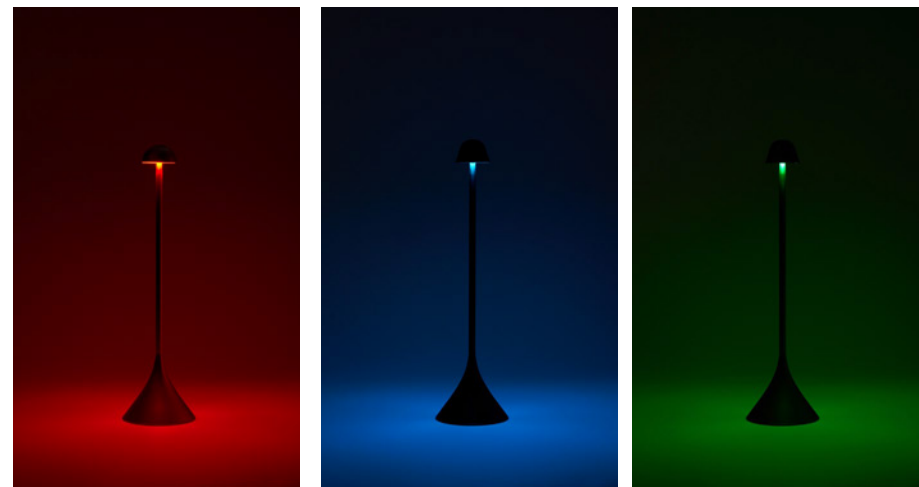

Lampe de table synchronisable à l'infini - Lumière blanche froide ou chaude + 7 couleurs d'éclairage - Puissance lumineuse maximale : 120 lm - Variateur d'intensité - Commande tactile - Résistante à l'eau (IPX4) - Autonomie : Jusqu'à 10h (testée à 75% de luminosité) - Rechargeable par USB-C (câble inclus) ou par induction - Temps de charge : 3h. Matériaux: Aluminium-ABS.

Infinitely synchronizable table lamp - Cool or warm white light + 7 lighting colors - Maximum light output: 120 lm - Dimmer - Touch control - Water-resistant (IPX4) - Battery life: Up to 10h (tested at 75% brightness) - Rechargeable via USB-C (cable included) or wirelessly - Charge time: 3h - Material: Aluminum - ABS.

- LAMPE AVEC 9 COULEURS DE LED / LAMP WITH 9 LED COLORS
- 120 LUMENS DE LUMINOSITÉ / 120 LUMENS BRIGHTNESS
- CONNECTABLE À L'INFINI / INFINITELY PAIRABLE
- VARIATEUR D'INTENSITÉ / DIMMER
- JUSQU'À 10 H D'AUTONOMIE / UP TO 10 H BATTERY LIFE
- RECHARGEABLE PAR USB-C / RECHARGEABLE VIA USB-C
- RECHARGEABLE PAR INDUCTION / WIRELESSLY RECHARGEABLE
- ADAPTÉE À UN USAGE EXTÉRIEUR (IPX4) / SUITABLE FOR OUTDOOR USE (IPX4)
- FINITION ALUMINIUM / ALUMINUM FINISHING

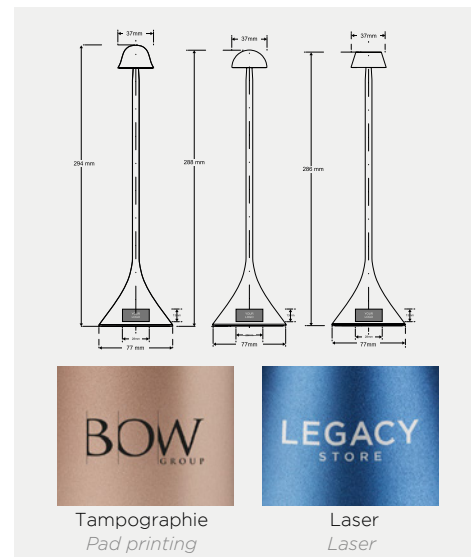

Ø3.7 x 28.6 x Ø7.7 cm | P. Brut: 375 g  
Ø1.46 x 11.26 x Ø3.063" / G.W: 0.83 lbs

Colisage: 20 p / Env. 8.5 kg  
Carton: 20 p / Approx. 18.74 lbs

# RAY LIGHT

Set of magnetic & synchronizable lamps  
Duo de lampes magnétiques et synchronisables à l'infini



SET DE LAMPES AVEC  
9 COULEURS DE LED



LAMP SET WITH  
9 LED COLORS

CONNECTABLE  
À L'INFINI



INFINITELY  
PAIRABLE

FIXATION  
MAGNÉTIQUE



MAGNETIC  
ATTACHMENT

RECHARGEABLE  
PAR USB-C



RECHARGEABLE  
VIA USB-C

ADAPTÉE À UN USAGE  
EXTÉRIEUR (IPX4)



SUITABLE FOR  
OUTDOOR USE (IPX4)

FINITION  
ALUMINIUM



ALUMINUM  
FINISHING



VG3



OB3



SR3



MN3



RA3

# RAY LIGHT

Design by neil poulton



Duo de lampes magnétiques - Synchronisable à l'infini - Lumière blanche froide ou chaude + 7 couleurs - + 9 programmes d'effets lumineux d'ambiance - Puissance lumineuse maximale : 75 lm - Variateur d'intensité - Résistante à l'eau (IPX4) - Autonomie : Jusqu'à 6h - Rechargeable par USB-C (câble inclus) - Temps de charge : 2h - Matériaux: Aluminium - Métal magnétique - ABS - Silicone. Marquage conseillé : Tampographie.

Set of magnetic lamps- Infinitely synchronizable - Cool or warm white light + 7 colors - + 9 special lighting effects - Maximum light output: 75 lm - Dimmer - Water-resistant (IPX4) - Battery life: Up to 6h - Rechargeable via USB-C (cable included) - Charging time: 2h - Material: Aluminum - Magnetic metal - ABS - Silicone. Suggested branding: Pad print.

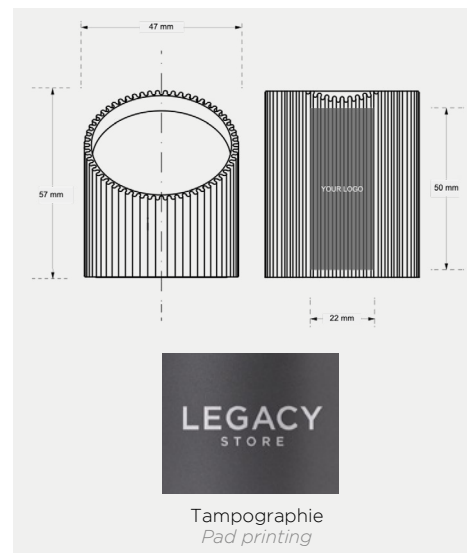

Ø4.7 x 5.7 cm / P. Brut: 270 g  
Ø1.85 x 2.2" / G.W: 0.59 lbs



Colisage: 40 p / Env. 12 kg  
Carton: 40 p / Approx. 26.45 lbs

# CONIC LAMP

Spherical portable LED Lamp / *Lampe LED portable sphérique*

# CONIC LAMP

Design by Lidia Gomez



- LAMPE AVEC 9 COULEURS DE LED**



LAMP WITH 9 LED COLORS
- VARIATEUR D'INTENSITÉ**



DIMMER
- JUSQU'À 12 H D'AUTONOMIE**



UP TO 12 H BATTERY LIFE
- RECHARGEABLE PAR USB-C**



RECHARGEABLE VIA USB-C
- CONTRÔLEUR ROTATIF POUR LE RÉGLAGE DE L'ÉCLAIRAGE**



ROTARY CONTROLLER FOR LIGHTING ADJUSTMENT
- ADAPTÉE À UN USAGE EXTÉRIEUR (IPX4)**



SUITABLE FOR OUTDOOR USE (IPX4)
- FINITION ALUMINIUM**



ALUMINIUM FINISHING

Lampe LED portable sphérique - Lumière blanche froide ou chaude + 7 couleurs - Variateur d'intensité - Système de contrôle rotatif pour les commandes d'éclairage - Résistante à l'eau (IPX4) - Autonomie : Jusqu'à 12h (testée à 75% de luminosité) - Rechargeable par USB-C (câble inclus) - Temps de charge : 4h - Matériaux : Aluminium-ABS.

*Spherical portable LED lamp - Cool or warm white light + 7 colors - Dimmer - Rotary control system for lighting commands - Water resistant (IPX4) - Battery life: Up to 12h (tested at 75% brightness) - Rechargeable via USB-C (cable included) - Charge time: 4h - Material: Aluminum - ABS.*

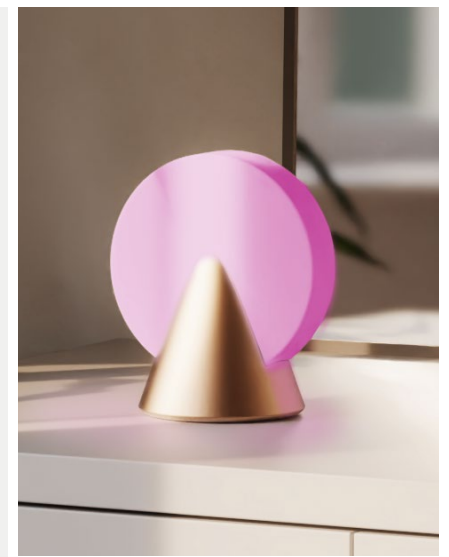
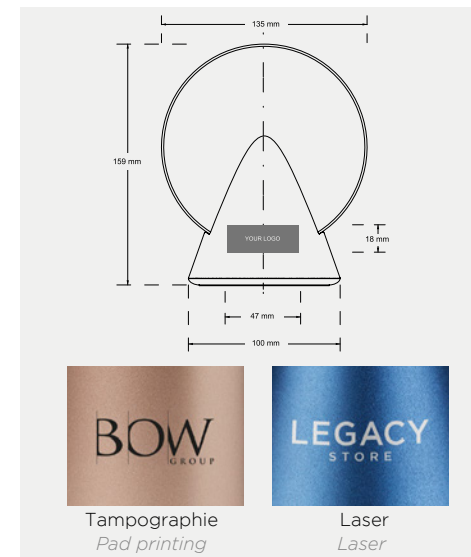
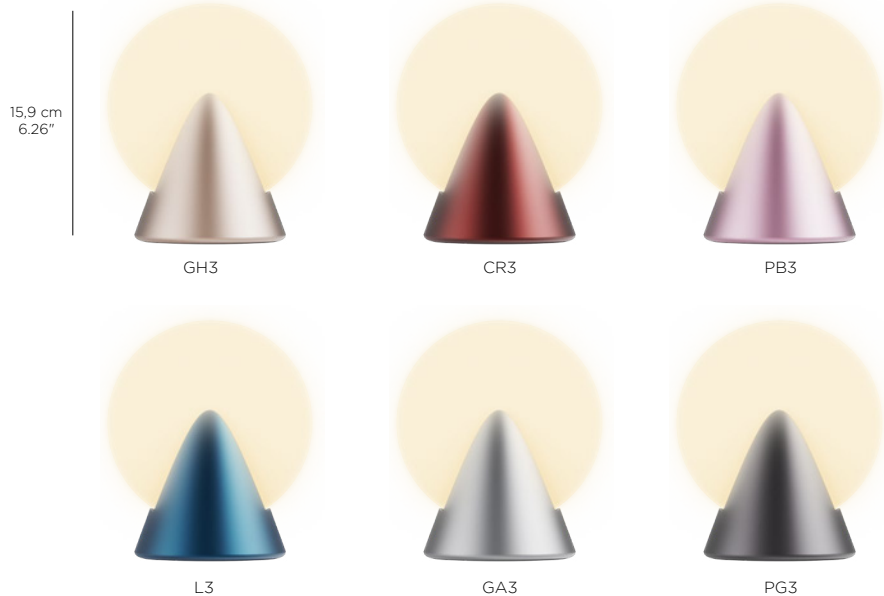

Ø13.5 x 15.9 cm / P. Brut: 440 g  
Ø5.31 x 6.26" / G.W: 0.97 lbs

Colisage: 12 p / Env. 7 kg  
Carton: 12 p / Approx. 15.43 lbs









## CITY LIGHT PRO

Desk lamp with built-in speaker / microphones & wireless charger  
 Lampe de bureau avec enceinte / microphones & chargeur à induction intégré

## CITY LIGHT PRO

Design by Manuela Simonelli & Andrea Quaglio



LAMPE LED	9 COULEURS D'AMBIANCE	VARIATEUR D'INTENSITÉ	COMMANDES TACTILES	DOUBLE MICROPHONE	ENCEINTE BLUETOOTH	CHARGEUR À INDUCTION	BATTERIE RECHARGEABLE	PORT USB-C
								
LED LIGHT	9 COLORS LIGHT	DIMMER	TOUCH CONTROLS	DUAL MICROPHONE	BLUETOOTH SPEAKER	WIRELESS CHARGER	RECHARGEABLE BATTERY	USB-C PORT

Lampe de bureau avec haut-parleur Bluetooth® et microphones - Station de charge sans fil Qi 10W - Enceinte Bluetooth® - Compatible avec tous les smartphones compatibles à la recharge sans fil Qi - Audioconférences mains-libres - 2 microphones avec technologie de réduction du bruit ambiant - Batterie intégrée - Autonomie : 24h pour l'éclairage seul - Connexion : USB-C (câble inclus). Matériaux : ABS - Cuir synthétique.

Wireless charging desk lamp with Bluetooth® speaker & microphones - 10W Qi wireless charging station - Bluetooth® speaker - Compatible with all Qi-enabled smartphones - Hands-free conference calls - Ambient noise-cancelling microphones - Operating with touch controls - Ideal position for video calls - Rechargeable built-in battery - Battery life: Up to 24h for lighting mode only - Charging time: 2h - Connection: USB-C (cable included). Material: ABS - Synthetic leather.

30 cm  
12"

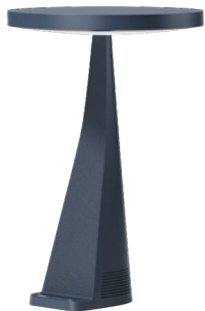

DB



BZ



N



D9



23 x 30 x 6.9 cm / P. Brut: 640 g  
 9.05 x 12 x 2.72" / G.W: 1.41 lbs



Colisage: Informations à confirmer  
 Carton: To be confirmed

LH99

NEW

## MIMI

Clip-on flexible reading lamp / Liseuse flexible avec clip  
Design by Manuela Simonelli & Andrea Quaglio



LH102

NEW

## HELIA

Bi-directional LED lamp / Lampe LED bi-directionnelle  
Design by Stefanie Kay



LAMPE AVEC 9  
COULEURS DE LED



LAMP WITH 9  
COLORS

BRAS  
FLEXIBLE



FLEXIBLE  
ARM

CLIP  
INTÉGRÉ



BUILT-IN  
CLIP

VARIATEUR  
D'INTENSITÉ



DIMMER

JUSQU'À 12 H  
D'AUTONOMIE



UP TO 12 H  
BATTERY LIFE

RECHARGEABLE  
PAR USB-C



RECHARGEABLE  
VIA USB-C

LAMPE LED  
MULTIFONCTIONNELLE



MULTIFUNCTIONAL  
LED LAMP

REPRODUCTION DES  
CYCLES NATURELS DE  
LA LUMIÈRE



NATURAL LIGHT  
CYCLES EFFECT

LAMPE AVEC 9  
COULEURS DE LED



LAMP WITH 9  
COLORS

VARIATEUR  
D'INTENSITÉ



DIMMER

JUSQU'À 12 H  
D'AUTONOMIE



UP TO 12 H  
BATTERY LIFE

RECHARGEABLE  
PAR USB-C



RECHARGEABLE  
VIA USB-C



D

LP

AP

DB

DR

X

Liseuse flexible avec clip - Angle réglable - Lumière blanche froide ou chaude + 7 couleurs - Variateur d'intensité - Puissance lumineuse maximale : 17 lm - Contrôle tactile - Autonomie : jusqu'à 12h (testé à 75% de luminosité) - Rechargeable par USB-C (câble inclus) - Temps de charge : 2h - Base livrée avec la lampe - Matériaux : Aluminium - ABS - Silicone. Marquage conseillé : tampographie.

Clip-on flexible reading lamp - Adjustable angle - Cool or warm white light + 7 colors - Maximum light output: 17 lm - Dimmer - Touch control - Battery life: Up to 12h (tested at 75% brightness) - Rechargeable via USB-C (cable included) - Charging time: 2h - Comes with a base - Material: Aluminum - ABS - Silicone. Suggested branding: pad print.

Lampe: Ø4.6 x 21.1 cm - Support: 7.5 x 4.5 cm I.P. Brut: 150 g  
Lamp: Ø1.81 x 8.31" - Stand: 2.95 x 1.77" / G.W: 0.33 lbs

Colisage: 20 p / Env. 4.2 kg  
Carton: 20 p / Approx. 9.26 lbs

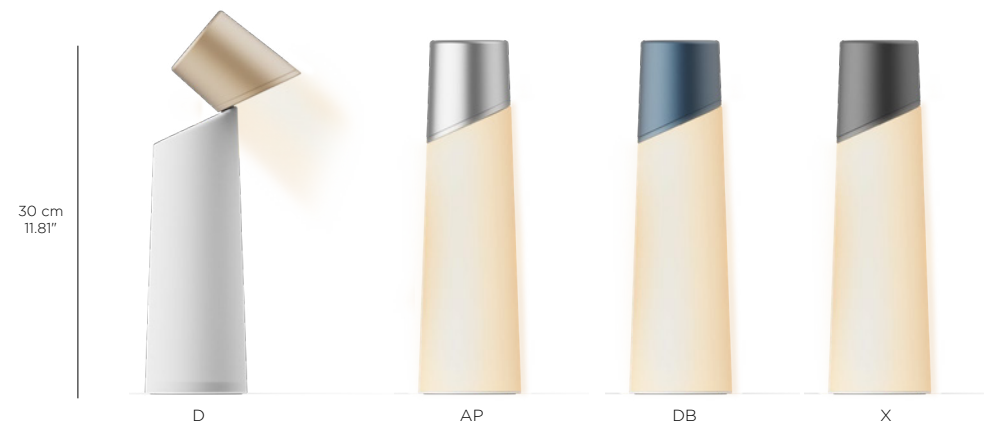

D

AP

DB

X

Lampe LED bi-directionnelle - lampe de lecture avec tête pivotante - lampe d'ambiance avec lumière blanche froide ou chaude + 7 couleurs - Reproduction des cycles naturels de la lumière (rythme circadien) - Variateur d'intensité - Commandes tactiles - Autonomie jusqu'à 12 heures - Rechargeable par USB-C (câble inclus) - Temps de charge 3h - Matériau : ABS. Marquage conseillé : tampographie.

Bi-directional LED lamp - reading lamp with swivel head - mood lamp with cool or warm white light + 7 colors - Natural light reproduction function (circadian rhythm) - Dimmer - Touch controls - Up to 12h hour battery life - Rechargeable via USB-C (cable included) - Charging time 3h - Material: ABS. Suggested branding: pad print.

Ø8.7 x 30 cm I.P. Brut: 500 g  
Ø3.42 x 11.81" / G.W: 1.10 lbs

Colisage: Informations à confirmer  
Carton: To be confirmed

# CARE

PRENDRE SOIN DE SOI

## CARE *PRENDRE SOIN DE SOI*



### HORIZON COLLECTION



DIFFUSER



DISPENSER



SAFETOUCH



NEW  
MAGSPRAY



THERMO  
BOTTLE

### NOMADAY COLLECTION



UV  
STRAW



NEW  
UV  
DRINK

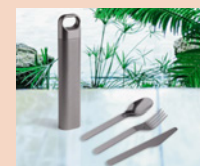

NEW  
UV  
PICNIC SET



PILLBOX



THERMO  
BOTTLE

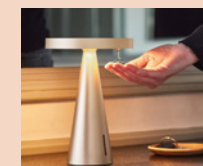

MANO

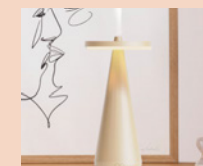

NEW  
DIVA



ROMINO



NEW  
ARIA



NEW  
BIRDY

### OBLIO COLLECTION

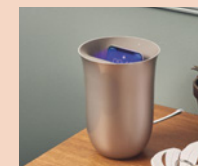

OBLIO



BOX



NEW  
DUO

### ZEN COLLECTION

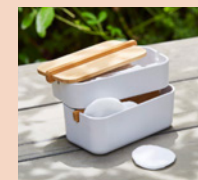

ZEN  
COLLECTION

# HORIZON DIFFUSER

Aromatherapy humidifier and mist maker / Humidificateur et brumisateuse aromatherapique

# HORIZON DIFFUSER

Design by natacha.sacha



DIFFUSION SILENCIEUSE  
AVEC TECHNOLOGIE  
ULTRASONIQUE



SILENT DIFFUSION  
WITH ULTRASONIC  
TECHNOLOGY

BRUME FRAÎCHE  
INOFFENSIVE



COOL MIST SAFE  
FOR USE

JUSQU'À 12H  
D'AUTONOMIE



UP TO 12 HOURS  
BATTERY LIFE

CAPACITÉ DU  
RÉSERVOIR 1L



TANK CAPACITY  
34 fl.oz

ARRÊT AUTOMATIQUE EN  
CAS DE MANQUE D'EAU



AUTOMATIC SHUT-OFF  
WHEN WATER TANK  
IS EMPTY

RECHARGEABLE  
PAR USB-C



RECHARGEABLE  
VIA USB-C



D

O1

LB1

X



Diffuseur d'huiles essentielles et humidificateur à brume - 12h d'autonomie continue - capacité du réservoir 1 L - Cycle de diffusion réglable - arrêt automatique lorsque le réservoir d'eau est vide - Rechargeable par USB-C (câble inclus). Matériaux : Aluminium/ABS.

Essential oil diffuser and mist humidifier - 12h continuous mist - 33 oz tank capacity - Adjustable diffusion cycle - waterless auto-off - Rechargeable via USB-C.(cable included). Material: Aluminum / ABS.

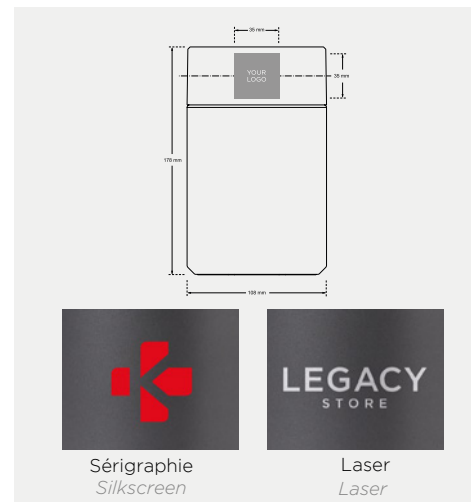

Ø10.8 x 17.8 cm | P. Brut: 530 g  
Ø4.25 x 7.01" | G.W: 1,17 lbs



Colisage : 12p/8 kg  
Carton: 12p/ 18 lbs

# HORIZON DISPENSER

Automatic gel or soap dispenser / Distributeur automatique de gel ou de savon



DISTRIBUTEUR DE GEL  
SANS CONTACT



CONTACTLESS GEL  
DISPENSER

DÉTECTION  
AUTOMATIQUE DES MAINS



AUTOMATIC HAND  
DETECTION

CAPACITÉ  
400 ML



13.5 oz  
CAPACITY

FONCTIONNE AVEC  
DU SAVON LIQUIDE



WORKS WITH  
LIQUID SOAP

JUSQU'À 6 MOIS  
D'AUTONOMIE



UP TO 6 MONTHS  
BATTERY LIFE

PORT DE  
CHARGE USB-C



USB-C  
CHARGING PORT



D



O1



LB1



X

# HORIZON DISPENSER

Design by natacha.sacha



Distributeur automatique de gel ou de savon pour maison et bureau - Fontionne avec du savon liquide - Batterie rechargeable intégrée - Grand réservoir d'une capacité de 400ml pour une utilisation quotidienne - Débit de la pompe réglable avec valve anti-goutte - Autonomie : 6 mois - Temps de charge: 4h - Rechargeable par USB-C (câble inclus) - Matériaux : Aluminium - ABS.

Home & office automatic gel or soap dispenser - Works with liquid soap - Built-in rechargeable battery - Large 400ml / 13.5oz tank capacity for daily usage - Adjustable pump flow with no-drip valve - Battery life: 6 month - Charging time: 4h - Rechargeable via USB-C (cable included) - Material: Aluminum - ABS.

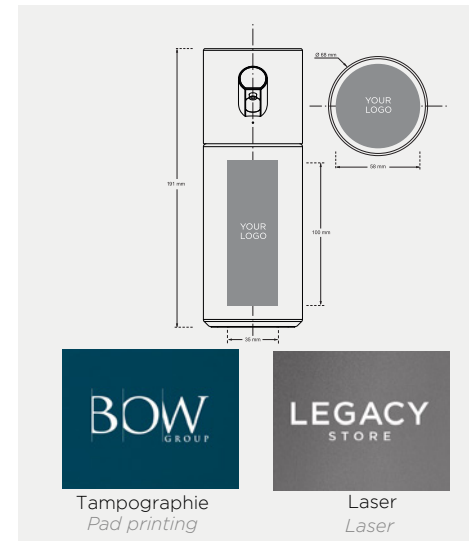

Distributeur : Ø7.5 x 19.1 cm / P. Brut: 380 g  
Dispenser: Ø2.95 x 7.52" / G.W: 0.83 lbs



Colisage: 20p / Env. 8.2 kg  
Carton: 20p / Approx. 18.08 lbs

# HORIZON SAFETOUCH

Contactless door opener & keyring / *Porte-clés & ouvre-porte sans contact*  
Design by natacha.sacha



Crédit photo : @natacha.sacha.

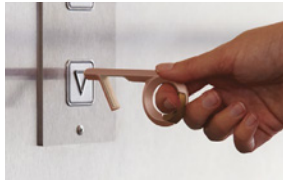

D

O1

LB1

X

Porte-clé & ouvre-porte sans contact - Stylet en silicone antibactérien - Presse-bouton pour ascenseur/distributeur/interrupteur - Crochet pour ouverture ou fermeture de robinets et pousser ou tirer des poignées de portes - Passe-doigt résistant avec mousqueton intégré pour l'accrocher à vos clés - Matériaux : Aluminium - Silicone. Marquage conseillé: laser - tampographie.

Contactless key ring & door opener - Antibacterial silicone stylus - Button presser for lift/ATM machine/switch - Hook for opening or closing taps and pushing or pulling door handles - Strong finger loop with integrated carabiner for hanging on your keys - Material: Aluminum - Silicone. Suggested branding: laser - pad print.

9 x 4 x 0.9 cm / P.Brut : 40 g  
3.54 x 1.57 x 0.35" / G.W: 0.09 lbs

Colisage: 100p / 4.45 kg  
Carton : 100p / 9.7 lbs

# HORIZON MAGSPRAY

Pocket spray with Magsafe / *Vaporisateur de poche avec Magsafe*  
Design by natacha.sacha



VAPORISATEUR  
DE POCHE



POCKET  
SPRAY

POUR SOLUTION HYDROALCOOLIQUE  
OU PARFUM



FOR HYDROALCOLIC LIQUID  
OR PERFUME

FIXATION MAGNÉTIQUE -  
COMPATIBLE MAGSAFE



MAGNETIC ATTACHMENT  
MAGSAFE COMPATIBLE

RECHARGEABLE



REFILLABLE



D



O1

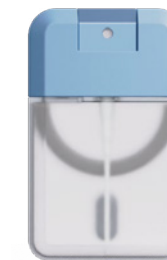

LB1



X

Vaporisateur de poche - Rechargeable - Contenant pour solution hydroalcoolique ou parfum - Capacité de 30ml - Fixation magnétique Magsafe - Matériaux : Aluminium-ABS. Marquage conseillé: laser - tampographie.

Pocket spray - Refillable - Container for hydroalcoholic liquid or perfume - 30ml capacity - Magsafe magnetic attachment - Material: Aluminum - ABS. Suggested branding: laser - pad print.

9 x 6.2 x 1.2 cm / P. Brut: 90 g  
3.54 x 0.39 x 2.37" / G.W: 0.19 lbs

Colisage: Informations à confirmer  
Carton: To be confirmed

# HORIZON THERMO BOTTLE

Vacuum insulated stainless steel bottle (17 fl. oz) / Bouteille isotherme en acier inoxydable (500 ml)



# HORIZON THERMO BOTTLE

Design by natacha.sacha



- CAPACITÉ 500 ML**



17 FL. oz CAPACITY
- ISOLATION SOUS VIDE DOUBLE PAROI**



DOUBLE-WALL VACUUM INSULATION
- 24h FROID 12h CHAUD**



24h COLD 12h HOT
- ÉTANCHE**



LEAKPROOF
- MOUSQUETON INTÉGRÉ**



BUILT-IN CLIP
- ACIER INOXYDABLE 18/8**



18/8 STAINLESS STEEL
- SANS BPA**



BPA FREE
- POUR TOUTE BOISSON**



FOR ALL BEVERAGES

Élégante bouteille à double isolation pour conserver votre liquide froid ou chaud pendant une longue période - Sans BPA - capacité 500 ml - Conserve les liquides chauds pendant 12 heures et les liquides froids pendant 24 heures. Matériaux: Acier inoxydable - ABS.

Elegant double insulated bottle for keeping your liquid cold or hot for long period - BPA-free - 500 ml / 16.9 oz capacity - Keep hot liquids for 12 hours and cold for 24 hours. Material: Stainless steel - ABS.



D O1 LBI X



Ø7.6 x 24.5 cm | P.Brut: 420g  
Ø2.9 x 9.65" | G.W: 0.93 lbs



Colisage: 20p / 9.15 kg  
Carton: 20 p / 20.17 lbs

## NOMADAY UV STRAW

Reusable straw with UV-C sterilizing carrying case  
Paille réutilisable avec étui de stérilisation UV-C

AWARD



reddot winner 2022



PAILLE  
RÉUTILISABLE



REUSABLE  
STRAW

ADAPTÉ POUR  
LE VOYAGE



SUITABLE  
FOR TRAVEL

LED UV  
ANTI-BACTÉRIENNE



ANTI-BACTERIAL  
UV LED

ÉLIMINE 99,9%  
DES BACTÉRIES



KILLS UP TO 99.9%  
OF BACTERIA

DÉSINFECTION AUTOMATIQUE  
ET COMPLÈTE EN 1 MIN



AUTOMATIC & FULL  
SANITIZING IN 1 MIN

RECHARGEABLE  
PAR USB-C



RECHARGEABLE  
VIA USB-C



DG1



DR



N



DB



D



X

Paille réutilisable en acier inoxydable avec étui de transport - Contribue à réduire l'utilisation de pailles jetables et à éviter les déchets plastiques - Solution de désinfection par UV-C validée par un laboratoire tiers avec une efficacité prouvée contre la plupart des bactéries et virus - Batterie rechargeable - 1x Brosse nettoyante (incluse) - Rechargeable par USB-C (câble inclus) - Matériaux : Aluminium - Acier inoxydable - ABS. Marquage conseillé: laser - tampographie.

Reusable stainless steel straw with UV-C - Helps reduce use of disposable straws and prevent plastic waste - UV-C sanitizing solution validated by third party laboratory with proven efficiency against most common bacteria and viruses - Rechargeable battery - 1x cleaning brush (included) - Rechargeable par USB-C (cable included) - Material: Aluminum - Stainless steel - ABS. Suggested branding: laser - pad print.

Ø2.4 x 12.9 cm / P. Brut 112 g  
Ø0.94 x 5.083" / G.W: 0.22 lbs

Colisage: 60p / Env. 7.2 kg  
Carton: 60p / Approx. 15.87 lbs

## NOMADAY UV PICNIC SET

Reusable cutlery set with UV-C sanitizer / Set de couverts réutilisables avec stérilisateur UV-C  
Design by Guillaume Delvigne



COUVERTS RÉUTILISABLES  
EN ACIER INOXYDABLE



REUSABLE STAINLESS  
STEEL CUTLERIES

ADAPTÉ POUR  
LE VOYAGE



SUITABLE  
FOR TRAVEL

LED UV  
ANTI-BACTÉRIENNE



ANTI-BACTERIAL  
UV LED

ÉLIMINE 99,9%  
DES BACTÉRIES



KILLS UP TO 99.9%  
OF BACTERIA

DÉSINFECTION AUTOMATIQUE  
ET COMPLÈTE EN 1 MIN



AUTOMATIC & FULL  
SANITIZING IN 1 MIN

RECHARGEABLE  
PAR USB-C



RECHARGEABLE  
VIA USB-C



DG1



DR



N



DB



D



X

Couverts réutilisables en acier inoxydable (fourchette, couteau et cuillère) - Doté d'une LED UV-C unique pour désinfecter vos couverts et les protéger des bactéries et des virus - Batterie rechargeable intégrée - Rechargeable par USB-C (câble inclus) - Matériaux : Aluminium - Acier inoxadable - ABS. Marquage conseillé : laser - tampographie.

Reusable stainless-steel cutleries (fork, knife and spoon) - Boasting unique ultraviolet sanitizing LED to keep your essentials away from bacteria and viruses - Built-in rechargeable battery - Rechargeable via USB-C (cable included) - Material: Aluminum - Stainless steel - ABS. Suggested branding: laser - pad print.

Étui: 19.3 x 4 x 2.6 cm / P. Brut: Env. 230 g  
Case: 7.60 x 1.57 x 1.02" / G.W: Approx. 0.51 lbs

Colisage: Informations à confirmer  
Carton: To be confirmed

## NOMADAY PILLBOX

Travel pillbox with 7 compartments / *Pillulier de voyage avec 7 compartiments*  
Design by Guillaume Delvigne



## NOMADAY UV DRINK

Bottle with UV-C sanitizer (17 fl. oz)  
*Bouteille avec stérilisateur UV-C (500 ml)*



Award



reddot winner 2023



PILLULIER



PILL BOX

ADAPTÉE POUR  
LE VOYAGE



SUITABLE  
FOR TRAVEL

7  
COMPARTIMENTS



7  
COMPARTMENTS

SANS BPA



BPA FREE

FINITION  
ALUMINIUM



ALUMINIUM  
FINISHING

GOURDE  
RÉUTILISABLE



REUSABLE  
BOTTLE

LED UV  
ANTI-BACTÉRIENNE



ANTI-BACTERIAL  
UV LED

ÉLIMINE 99,9%  
DES BACTÉRIES



KILLS 99.9%  
OF BACTERIAS

DÉSINFECTION AUTOMATIQUE  
ET COMPLÈTE EN 1 MIN



AUTOMATIC & FULL  
SANITIZING IN 1 MIN

RECHARGEABLE  
PAR USB-C



RECHARGEABLE  
VIA USB-C



Pilulier semainier pour votre traitement ou garder vos médicaments toujours avec vous où que vous alliez - 7 compartiments pour votre prescription hebdomadaire ou simplement pour ranger certains de vos médicaments de base lors de vos voyages - Facile à nettoyer - Grands compartiments et finition de qualité supérieure. Matériaux : Aluminium - ABS. Marquage conseillé: sérigraphie - laser.

*Stylish pill box to keep your treatment or essential medicines always with you wherever you go - 7 distinguished compartments for your weekly prescription or simply to store some of your basic medicines while traveling - Easy to clean inner material - Large compartments and premium finishing. Material: Aluminum - ABS. Suggested branding: silkscreen / laser.*

17 x 3 x 1.6 cm / P.Brut: 82 g  
6.7 x 1.2 x 0.4" / G.W: 0.31 lbs

Colisage: 40p / 3.7 kg  
Carton: 40p / 8.16 lbs

Bouteille d'eau en aluminium de qualité alimentaire - Capacité de 500 ml - Aide à réduire l'utilisation de bouteilles en plastique jetables - Sans BPA - Stérilisation par UV-C - Batterie rechargeable, jusqu'à 10 cycles sur une seule charge - Large choix de couleurs. Matériaux : Aluminium de qualité alimentaire - ABS. Marquage conseillé: laser - tampographie.

*Food grade aluminum water bottle - 500ml / 17oz capacity - Helps reducing use of disposable plastic bottles - BPA free - UV-C sanitizing - Rechargeable battery, up to 10 cycles on a single charge - large selection of colors. Material: Food grade aluminum - ABS. Suggested branding: laser - pad print.*

10 x 4.6 x 21 cm I.P. Brut : 280 g  
3.94 x 1.57 x 8.27» | G.W: 0.62 lbs

Colisage: Informations à confirmer  
Carton: To be confirmed

# MANO

Automatic liquid soap & hydroalcoholic gel dispenser with LED light  
 Distributeur automatique de savon liquide et de gel hydroalcoolique avec lumière LED

# MANO

Design by Manuela Simonelli & Andrea Quaglio



AWARDS



DISTRIBUTEUR DE GEL SANS CONTACT



CONTACTLESS GEL DISPENSER

DÉTECTION AUTOMATIQUE DES MAINS



AUTOMATIC HAND DETECTION

LAMPE LED



LED LIGHT

CAPACITÉ 160ML



5.4 oz CAPACITY

DÉBIT DE POMPE RÉGLABLE



ADJUSTABLE PUMP FLOW

JUSQU'À 12 MOIS D'AUTONOMIE



UP TO 12 MONTHS BATTERY LIFE

RECHARGEABLE PAR USB-C



RECHARGEABLE VIA USB-C

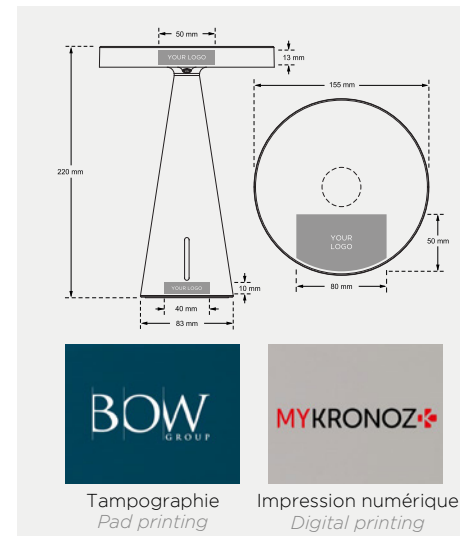

Ø 22 x 15.5 x Ø 8.2 cm / P. Brut: 870 g  
 Ø 8.66 x 6.10 x Ø 3.23" / G.W: 1.92 lbs

Colisage: 6p / Env. 6.4 kg  
 Carton: 6p / Approx. 14.11lbs

# DIVA

Aromatherapy humidifier and mist maker with LED light  
Humidificateur et brumisateur aromatherapique avec lumière LED

# DIVA

Design by Manuela Simonelli & Andrea Quaglio



### AWARDS



reddot winner 2023



DESIGN AWARD 2023



DIFFUSION SILENCIEUSE  
AVEC TECHNOLOGIE  
ULTRASONIQUE



SILENT DIFFUSION  
WITH ULTRASONIC  
TECHNOLOGY

BRUME FRAÎCHE  
INOFFENSIVE



COOL MIST SAFE  
FOR USE

LAMPE AVEC 9  
COULEURS DE LED



LAMP WITH 9 LED  
COLORS

VARIATEUR  
D'INTENSITÉ



DIMMER

ARRÊT AUTOMATIQUE EN  
CAS DE MANQUE D'EAU



AUTOMATIC SHUT-OFF  
WHEN WATER TANK  
IS EMPTY

RECHARGEABLE  
PAR USB-C



RECHARGEABLE  
VIA USB-C



N



W



D



TC



DG3



Diffuseur d'ambiance pour brume froide et huiles essentielles avec éclairage LED d'ambiance - Design contemporain avec finition en aluminium de qualité supérieure - Réservoir d'eau intégré - Commandes tactiles pour interagir avec la lampe LED - Luminosité et sélection des couleurs réglables - Rechargeable par USB-C (câble inclus). Matériaux : Aluminium - ABS.

Home diffuser for cold mist and essential oils with ambient LED lighting - contemporary design with premium aluminium finishing - built-in water tank - Touch controls to interact with LED lamp - Adjustable brightness and color selection - Rechargeable par USB-C (cable included). Material: Aluminum - ABS.

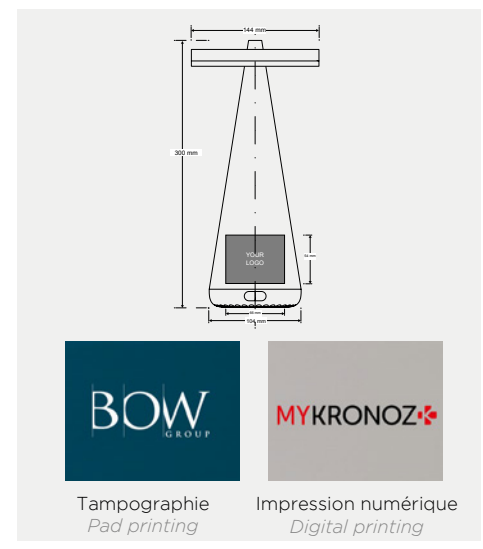

Ø8.4 x Ø13.5 x 27 cm / P.Brut: 870 g  
Ø 8.66 x 6 .10 x Ø 3.23" | G.W: 1.92 lbs



Colisage: Informations à confirmer  
Carton: To be confirmed

# ROMINO

Compact waterless diffuser / Diffuseur compact sans eau

# ROMINO

Design by Manuela Simonelli & Andrea Quaglio



AWARD



reddot winner 2023



DIFFUSEUR COMPACT ET SILENCIEUX



COMPACT & SILENT DIFFUSER

FONCTIONNE SANS EAU



WORKS WITHOUT WATER

ARRÊT AUTOMATIQUE TOUTES LES 2 HEURES



AUTOMATIC SHUT-OFF EVERY 2 HOURS

JUSQU'À 8 HEURES D'AUTONOMIE



UP TO 8 HOURS BATTERY LIFE

RECHARGEABLE PAR USB-C



RECHARGEABLE VIA USB-C

Élégant diffuseur d'arômes compact sans eau - Quelques gouttes d'huiles essentielles pour procurer du bien-être et un air agréable à respirer - Autonomie: 8h - Temps de charge: 2h - Rechargeable par USB-C (câble inclus). Matériaux : Aluminium - ABS.

Elegant compact aroma diffuser without water - Few essential oils drops to provide wellness and good breathing air - Battery life: 8h - Charging time: 2h - Rechargeable via USB-C (cable included). Material: Aluminum - ABS.



DG1

LP

LB1

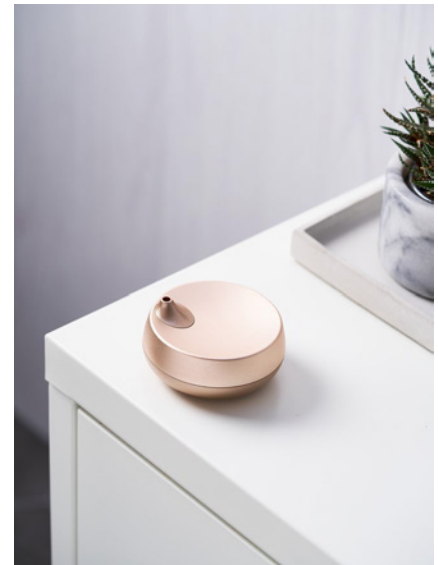
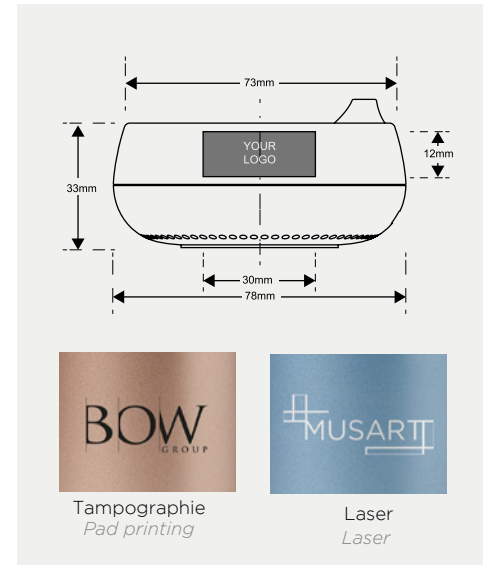

Ø7.8 x 3.3 cm / P.Brut: 148 g  
2.87 x 1.29" | G.W: 0.33 lbs

Colisage: 40p / Env. 6 kg  
Carton: 40p / Approx. 13.22 lbs

LH104

NEW

## ARIA

Air purifier / Purificateur d'air  
Design by Manuela Simonelli & Andrea QuaglioPURIFICATEUR  
D'AIRAIR  
PURIFIERFILTRE  
HEPAHEPA  
FILTERÉCRAN DE  
CONTRÔLE TACTILETOUCH CONTROL  
PANEL3 VITESSES  
AJUSTABLES3 ADJUSTABLE  
SPEEDSMODE  
SILENCIEUXSILENT  
MODEALIMENTATION  
VIA USB-CPOWER SUPPLY  
VIA USB-C

BG



W



LG

Purificateur d'air - Filtre HEPA - Convient à une pièce jusqu'à 20 m<sup>2</sup> - 3 vitesses - Panneau de commandes tactiles - Mode de fonctionnement silencieux - Connecteur USB-C pour l'alimentation. Matériaux : ABS. Marquage conseillé : laser - tampographie.

Air purifier - HEPA filter - Suitable for room up to 20 sqm (215 sqft) - 3 speeds - Touch controls panel - Quiet operating mode - USB-C connector for power. Material: ABS. Suggested branding: laser - pad print.

Ø21 x 38 cm / P.Brut: TBC  
Ø8.27 x 14.96" / G.W: TBC

Colisage: Informations à confirmer  
Carton: To be confirmed

LH103

NEW

## BIRDY

Air quality monitor / Capteur de qualité d'air  
Design by Manuela Simonelli & Andrea Quaglio

AWARD

CAPTEUR  
CO<sub>2</sub>CO<sub>2</sub>  
SENSORINDICATEUR LUMINEUX  
POUR LA QUALITÉ DE L'AIRLIGHT INDICATOR  
FOR AIR QUALITYSUIVI DE LA TEMPÉRATURE  
INTÉRIEURE ET DE  
L'HUMIDITÉINDOOR TEMPERATURE &  
HUMIDITY MONITORINGÉCRAN  
LEDLED  
DISPLAYALIMENTATION  
VIA USB-CPOWER SUPPLY  
VIA USB-C

D



LB1



X



LG

Capteur de qualité d'air - Une tête lumineuse conçue pour donner une indication visuelle de la qualité de l'air intérieur - Trois couleurs de lumière pour indiquer différents niveaux de qualité de l'air - Commande tactile pour allumer l'écran pendant quelques secondes et obtenir des données sur la qualité de l'air, la température et l'humidité relative - Rechargeable par USB-C (câble inclus). Matériaux : Aluminium - ABS. Marquage conseillé : laser - tampographie.

Air quality monitor - A light head designed to give a visual indication of indoor air quality - Three light colors to indicate different levels of air quality - Touch control to turn on the display for a few seconds and get data on air quality, temperature and relative humidity - Rechargeable via USB-C (cable included). Material: Aluminum - ABS. Suggested branding: laser - pad print.

10,6 x 11,9 cm / P. Brut: 220 g  
4,17 x 4,68" / G.W: 0,48 lbs

Colisage: Informations à confirmer  
Carton: To be confirmed

# OBLIO

Wireless charging station with built-in UV-C sanitizer  
Station de charge à induction avec stérilisateur UV-C intégré

# OBLIO

Design by Manuela Simonelli & Andrea Quaglio



### AWARDS

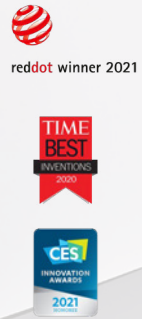

Station de charge à induction 10W avec stérilisateur UV intégré - Certifié Qi - Charge rapide : environ 3h pour une charge complète du smartphone - Lampe UV-C antibactérienne - Élimine 99,9% des germes et bactéries sur l'écran de votre smartphone en 20 minutes - Retournez votre smartphone pour une désinfection complète à 360° - Testé en laboratoire contre les bactéries communes - Efficacité scientifiquement prouvée contre les virus dont le H1N1 - Cycle de désinfection automatique - Indicateur LED pour positionnement correct et statut de charge - Compatible avec les smartphones dotés de la technologie de charge Qi avec des dimensions allant jusqu'à 8,3 cm de largeur / 1,05 cm d'épaisseur, coque incluse (non métallique) - Détection d'objets étrangers - Rechargeable par USB-C (câble inclus) et sur adaptateur secteur certifié Quick Charge 3.0 ou un adaptateur secteur USB DC 9V/2A (non inclus) - Matériaux : ABS - Finition gomme.

10W Wireless charging station with built-in UV sanitizer - Qi-certified - Fast charging: approximately 3h required for a full smartphone charge - Antibacterial UV-C light - Eliminates 99.9% of germs and bacteria on your smartphone screen in 20 minutes - Flip your smartphone for a complete 360° disinfection - Laboratory tested against common bacteria - Scientifically proven to be effective against viruses including H1N1 - Automatic sanitizing cycle - LED indicator for proper placement and charging status - Compatible with Qi-enabled smartphones with size up to 8.3 cm wide / 1.05 cm thick including case (not metal) - Foreign object detection - Rechargeable via USB-C (cable included) and a Quick Charge 3.0 certified power adapter or a USB DC 9V/2A power adapter (not included) - Material: ABS - Rubber finishing.

LED UV-C ANTIBACTÉRIENNE



ANTIBACTERIAL UV-C LED

ÉLIMINE 99.9% DES BACTÉRIES



KILLS UP TO 99.9% OF BACTERIA

DÉSINFECTION AUTOMATIQUE ET COMPLÈTE DE L'ÉCRAN EN 20 MIN



AUTOMATIC & FULL SCREEN SANITIZING IN 20 MIN

STATION DE CHARGE À INDUCTION



WIRELESS CHARGER

CHARGE RAPIDE 10W



10W FAST CHARGING

COMPATIBLE AVEC LES SMARTPHONES DOTÉS DE LA TECHNOLOGIE Qi



COMPATIBLE WITH Qi ENABLED SMARTPHONES



N



DB



D

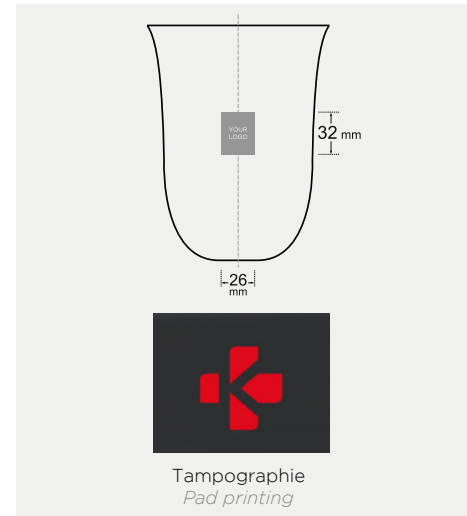

Ø7 x Ø13,6 x 17,5 cm | P. Brut : 775 g  
Ø 2.7 x Ø 5.35 x 6.89" | GW : 1.71 lbs



Colisage : 12 p / 10,220 kg  
Carton : 12p / 22.5 lbs

## OBLIO BOX

Wireless charging station with built-in UV-C sanitizer  
Station de charge à induction avec stérilisateur UV-C intégré



LED UV-C  
ANTIBACTÉRIENNE



ANTIBACTERIAL  
UV-C LED

ÉLIMINE 99.9%  
DES BACTÉRIES



KILLS UP TO 99.9%  
OF BACTERIA

DÉSINFECTION AUTOMATIQUE  
ET COMPLÈTE EN 5 MIN



AUTOMATIC & FULL  
SANITIZING IN 5 MIN

STATION DE CHARGE  
À INDUCTION



WIRELESS  
CHARGER

CHARGE  
RAPIDE 10W



10W FAST  
CHARGING

COMPATIBLE AVEC LES  
APPAREILS DOTÉS DE LA  
TECHNOLOGIE Qi



COMPATIBLE WITH Qi  
ENABLED DEVICES



W



N

## OBLIO BOX

Design by Manuela Simonelli & Andrea Quaglio



Boîtier de stérilisation UV-C avec chargeur à induction 10W - Certifié Qi - Charge rapide : environ 3h pour une charge complète du smartphone - Lampe UV-C antibactérienne - Élimine 99,9% des germes et bactéries sur votre smartphone en 5 minutes - Désinfectant UV : tout produit pouvant entrer dans le boîtier de stérilisation, comme les lunettes, montre, bijoux, écouteurs, masques, smartphones - Stérilisation UV à 360° - Testé en laboratoire contre les bactéries communes - Efficacité scientifiquement prouvée contre les virus dont le H1N1 - Cycle de désinfection automatique - Indicateur LED pour positionnement correct et statut de charge - Compatible avec la plupart des téléphones et appareils prenant en charge la charge à induction et compatibles Qi - Rechargeable par USB-C (câble inclus) et sur adaptateur secteur certifié Quick Charge 3.0 ou un adaptateur secteur USB DC 9V/2A (non inclus) - Matériaux : ABS.

UV-C sanitizer with built-in 10W wireless charger - Qi-certified - Fast charging: approximately 3h required for a full smartphone charge - Advanced anti-bacterial UV-C light - Eliminates 99,9% of your smartphone germs and bacteria in 5 minutes - UV sanitizer: any goods that can fit into the sanitizer, such as glasses, watch, jewelry, earphones, masks, smartphones - 360°UV sterilization - Cycle Laboratory tested against common bacteria - Scientifically proven to be effective against viruses including H1N1 - Unique and secured rotating closing cap - Automatic sanitizing cycle - LED indicator for proper placement and charging status - Compatible with most phones and devices that support wireless charging and are Qi-compatible - Foreign object detection - Rechargeable via USB-C (cable included) and a Quick Charge 3.0 certified power adapter or a USB DC 9V/2A power adapter (not included) - Material: ABS.

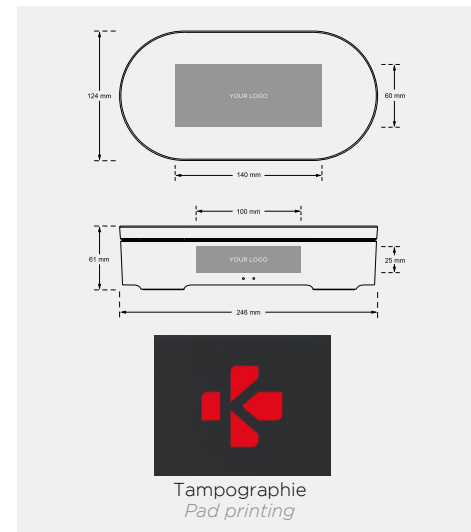

24.6 x 12.4 x 6.1 cm | P.Brut : 880 g  
9.68 x 4.88 x 2.40" | G.W: 1.94 lbs









Colisage: 12p/11 kg  
Carton: 12p/24.25 lbs

# OBLIO DUO

Dual wireless charging station with built-in UV-C sanitizer  
Double station de charge à induction avec stérilisateur UV-C intégré



<p><b>LED UV-C ANTIBACTÉRIENNE</b></p>  <p>ANTIBACTERIAL UV-C LED</p>	<p><b>ÉLIMINE 99.9% DES BACTÉRIES</b></p>  <p>KILLS UP TO 99.9% OF BACTERIA</p>	<p><b>DÉSINFECTION AUTOMATIQUE ET COMPLÈTE EN 5 MIN</b></p>  <p>AUTOMATIC &amp; FULL SANITIZING IN 5 MIN</p>	<p><b>CHARGE RAPIDE 2X15W</b></p>  <p>2X 15W FAST CHARGING</p>	<p><b>2 EMPLACEMENTS POUR SMARTPHONES</b></p>  <p>2 SMARTPHONES SLOTS</p>	<p><b>COMPATIBLE AVEC LES SMARTPHONES DOTÉS DE LA TECHNOLOGIE QI</b></p>  <p>COMPATIBLE WITH QI ENABLED SMARTPHONES</p>
--	--	---	---	--	--



Colors on request / Couleurs sur demande

# OBLIO DUO

Design by Manuela Simonelli & Andrea Quaglio



Double station de charge à induction 2x15W avec stérilisateur UV intégré - Certifié Qi - Charge rapide : environ 2h pour une charge complète du smartphone - Lampe UV-C antibactérienne (LED & CCFL) - Élimine 99,9% des germes et bactéries sur votre smartphone en quelques minutes - Testé en laboratoire contre les bactéries communes - Efficacité scientifiquement prouvée contre les virus dont le H1N1 - Couvercle de fermeture rotatif unique et sécurisé - Cycle de désinfection automatique - Indicateur LED pour positionnement correct et statut de charge - Compatible avec les smartphones dotés de la technologie de recharge sans fil Qi avec des dimensions allant jusqu'à 16,8cm de hauteur / 8,5 cm de largeur / 1,5 cm d'épaisseur, coque incluse (non métallique) - Détection d'objets étrangers - Alimentation : par USB-C (câble inclus) et sur adaptateur secteur certifié Quick Charge 45W (non inclus) - Matériaux : ABS. Marquage conseillé : Sérigraphie.

*2x 15W dual wireless charging station with built-in UV sanitizer - Qi-certified - Fast charging: approximately 2h required for a full smartphone charge - Advanced anti-bacterial UV-C light combination (LED & CCFL) - Eliminates 99,9% of your smartphone germs and bacteria in a few minutes - Cycle Laboratory tested against common bacteria - Scientifically proven to be effective against viruses including H1N1 - Unique and secured rotating closing cap - Automatic sanitizing cycle - LED indicator for proper placement and charging status - Compatible with Qi-enabled smartphones with size up to 168 mm length / 85 mm wide / 15 mm thick including case (not metal) - Foreign object detection - Power supply: via USB-C (cable included) and a Quick Charge 45W (not included) - Material: ABS. Suggested branding: Silkscreen.*

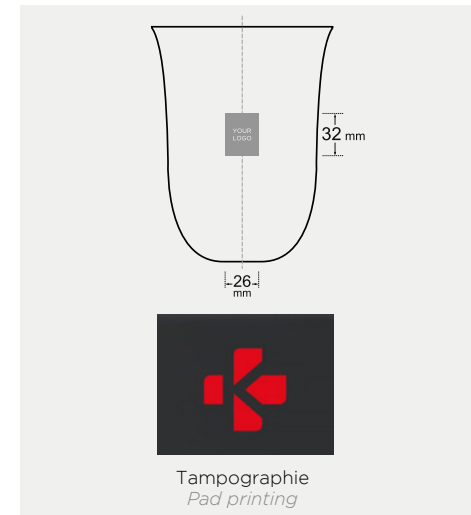

Ø 14,8x19,9 cm | P. Brut : 980 g  
Ø 5.8x7.835" | G.W : 2.16 lbs

Colisage : 12 p/ 13 kg  
Carton : 12p/ 28.6 lbs

# ZEN COLLECTION

Design by LEXON Studio

# ZEN COLLECTION

Design by LEXON Studio

LEXON<sup>®</sup>  
STUDIO

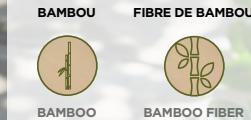

**LH39 - ZEN CUP**

**LH40 - ZEN LARGE CUP**

**LH42 - ZEN COTTON BOX**

**LH43 - ZEN TISSUE BOX**



W8

Pot pour brosses à dents - 4 compartiments  
Matériaux : bambou - fibre de bambou.  
Marquage conseillé : sérigraphie

8,4 x 8,4 x 10,5 cm | P. Brut: 250 g / Colisage :  
40p / 10,840 kg

*Toothbrush cup - 4 compartments - Material:  
bamboo / bamboo fiber. Suggested  
branding: silkscreen.*

3,31 x 3,31 x 4,13" | G.W: 0,55 lbs / Carton:  
40p / 23,9 lbs



W8

Rangement pour salle de bain -  
4 compartiments - Matériaux : bambou - fibre  
de bambou. Marquage conseillé : sérigraphie.

21 x 8,8 x 8 cm | P.Brut: 375g / Colisage:  
40p / 17,560 kg

*Bathroom organizer - 4 compartments -  
Material: bamboo / bamboo fiber. Suggested  
branding: silkscreen.*

8,3 x 3,5 x 3,1" | G.W: 0,8 lbs / Carton:  
40p / 38,7 lbs



W8

Boîtes de rangement pour salle de bain -  
Pour coton, cotons-tiges, maquillage...  
Matériaux : bambou - fibre de bambou.  
Marquage conseillé : sérigraphie.

15,4 x 8,4 x 9,4 cm | P. Brut: 430 g / Colisage :  
40p / 19,040 kg

*Bathroom organizer boxes - For cotton,  
cottons buds, make up... Material: bamboo /  
bamboo fiber. Suggested branding: silkscreen.*

6 x 3,3 x 3,7" | G.W: 0,95 lbs / Carton:  
40p / 42 lbs



W8

Boîte décorative pour mouchoirs en papier  
- Matériaux : bambou - fibre de bambou.  
Marquage conseillé : sérigraphie.

26,5 x 13,7 x 8 cm | P. Brut: 390 g / Colisage:  
40p / 24,8 kg

*Decorative tissue box - Material: bamboo  
/ bamboo fiber. Suggested branding:  
silkscreen.*

10,4 x 5,4 x 3" | G.W: 1,1 lbs / Carton: 40p /  
54,7 lbs

**CHARGE**  
CHARGER



**CHARGE** CHARGER



**POWERON**

**NEW**

**POWERUP**



**METALI-C**

**NEW**

**SOFTPOWER  
MAGBANK**



**SOFTPOWER  
WIRELESSBANK**

**POWERSOUND**



**OSLO ENERGY+**

**FINE TUBE POWER BANK 2**



**NOMADAY POWER BANK**

**NEW**

**PEAS POWER**



**TELA**

**NEW**

# POWERON

Dual USB wall fast charger - PD 30W  
 Chargeur secteur rapide avec double port USB - PD 30W

# POWERON

Design by LEXON Studio

AWARD



reddot winner 2023



PORT USB-C  
+ PORT USB-A



USB-C PORT  
+ USB-A PORT

TECHNOLOGIE DE CHARGE  
RAPIDE POWER DELIVERY (30 W)



POWER DELIVER FAST CHARGING  
TECHNOLOGY (30W)

CHARGE 2 APPAREILS  
SIMULTANÉMENT



CHARGE 2 DEVICES  
SIMULTANEOUSLY

ADAPTATEURS US + EU  
INCLUS US + EU



US + EU PLUGS  
INCLUDED

FORMAT  
COMPACT



COMPACT  
DESIGN

FINITION RÉSISSANTE  
CUIR SYNTHÉTIQUE



DURABLE SYNTHETIC  
LEATHER FINISHING



Chargeur secteur rapide avec double port USB - 1 Port USB-C PD + 1 Port USB-A QC 3.0 - Technologie de charge rapide Power Delivery (PD) - Jusqu'à 30W de puissance - Capable de recharger jusqu'à 2 appareils simultanément - Prises US + EU incluses - Format compact - Finition premium en cuir synthétique. Matériaux: Cuir synthétique - ABS.

Dual USB wall fast charger - 1 USB-C PD port + 1 USB-A QC 3.0 port - Power Delivery fast charging technology (PD) - Up to 30W of power - Can charge up to 2 devices simultaneously - US + EU plugs included - Compact design - Premium synthetic leather finish. Materials: Synthetic leather - ABS.

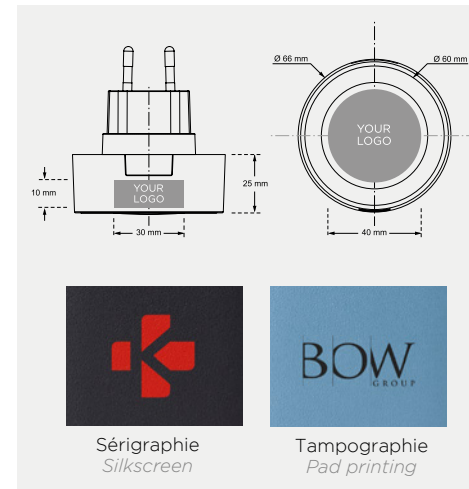

Ø 6.6 x 2.5 cm / P. Brut: 150 g  
 Ø 2.36 x 0.79" / G.W: 0.33 lbs









Colisage: 40p / Env. 6.9 kg  
 Carton: 40p / Approx. 15.21 lbs

**POWERUP**  
15W wireless charger  
Chargeur à induction 15W

**POWERUP**  
Design by LEXON Studio



<p><b>CHARGEUR À INDUCTION CERTIFIÉ Qi</b></p>  <p>Qi-CERTIFIED WIRELESS CHARGER</p>	<p><b>CHARGE RAPIDE 15W</b></p>  <p>15W FAST CHARGING</p>	<p><b>FONCTIONNE AVEC TOUS LES APPAREILS COMPATIBLES Qi</b></p>  <p>FONCTIONNE AVEC TOUS LES APPAREILS COMPATIBLES Qi</p>	<p><b>ULTRA FIN</b></p>  <p>EXTRA SLIM</p>	<p><b>CHARGEUR SECTEUR REQUIS</b></p>  <p>REQUIRES WALL CHARGER</p>	<p><b>FINITION CUIR SYNTHÉTIQUE ET ALUMINIUM</b></p>  <p>SYNTHETIC LEATHER &amp; ALUMINIUM FINISHING</p>
---	--	--	---	--	--

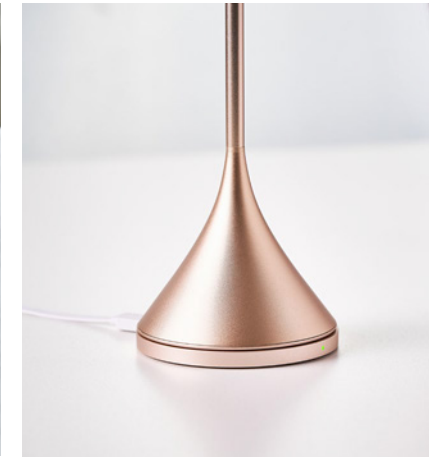

Chargeur sans fil 15W - Certifié Qi - Indicateur lumineux LED de chargement sans fil - Compatible avec tous les appareils compatibles Qi - Finition en cuir synthétique durable - Alimentation : utilisation recommandée par USB-C (câble inclus) et sur adaptateur secteur certifié Quick Charge 3.0 ou un adaptateur secteur USB DC 9V/2A (non inclus). Matériaux : Cuir synthétique / Aluminium / ABS.

15W wireless charger - Qi certified - Wireless charging LED light indicator - Compatible with all Qi-enabled devices - Durable synthetic leather finishing - Power supply: recommend to use with Quick Charge 3.0 power adapter (not included) or a DC 9V/2 power adapter (not included). Material: Synthetic leather / Aluminium / ABS.

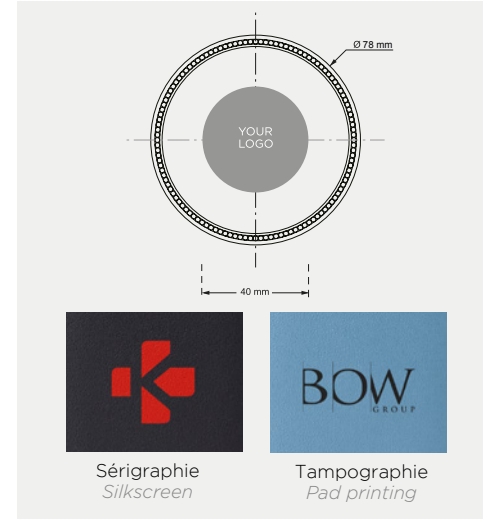

Ø7,8 x 0,6 cm / P. Brut: 70 g  
Ø3.07 x 0.24" / G.W: 0.15 lbs

Colisage: 60p / 6.1 kg  
Carton: 60p / 13.49 lbs

# METALI-C

USB-C cable / Câble USB-C

# METALI-C

Design by LEXON Studio

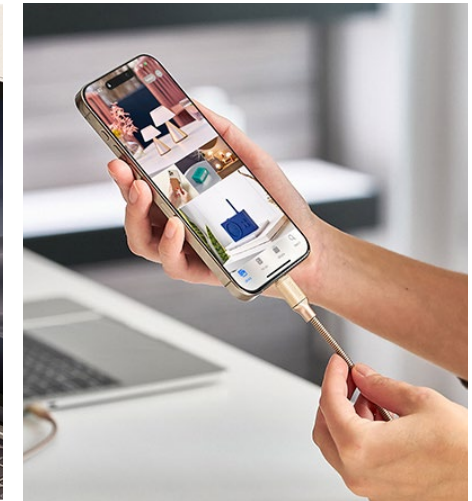

CÂBLE USB-C  
VERS USB-C



USB-C TO  
USB-C CABLE

1,5 m



5 FT

CHARGE RAPIDE  
JUSQU'À 100W



SUPPORTS FAST  
CHARGING UP TO 100W

HAUTE QUALITÉ ET  
DURABLE



HIGH-QUALITY &  
DURABLE

COMPATIBLE AVEC LA  
PLUPART DES APPAREILS  
MOBILES USB-C



COMPATIBLE WITH  
MOST USB-C  
MOBILE DEVICES

Câble USB-C - Câble de haute qualité et durable de 1,5m - Fonction magnétique cachée - Compatible avec la plupart des smartphones, tablettes et ordinateurs portables USB-C - Prise en charge de la norme de charge rapide PD 100W. Sangle de fermeture magnétique customisable. Matériaux : Métal - Cuir synthétique. Marquage conseillé : laser - tampographie.

USB-C cable - High-quality & durable 1.5m / 5ft cable - Magnetic suction function - Compatible with most USB-C smartphones, tablets, and laptops - Support fast charging standard PD 100W. Customisable Magnetic synthetic leather closing strap. Material: Metal - Synthetic leather. Suggested branding: laser - pad print.



D9



DB



N



AP



DR



1,5m | P.Brut : 7 g  
5 ft | G.W:0.22 lbs



Colisage : 60 p / 6,8 kg  
Carton: 60 p / 15 lbs

# SOFTPOWER MAGBANK

Compact magnetic wireless power bank Magsafe compatible  
Batterie sans fil compacte & magnétique compatible Magsafe

# SOFTPOWER MAGBANK

Design by Alain Berteau



BATTERIE EXTERNE  
3000 mAh



3000 mAh  
POWER BANK

COMPATIBLE MAGSAFE  
(iPhone 12 et plus récent)



MAGSAFE COMPATIBLE  
(iPhone 12 and newer)

CHARGEUR À  
INDUCTION CERTIFIÉ Qi



Qi-CERTIFIED  
WIRELESS CHARGER

FONCTIONNE AVEC TOUS  
LES APPAREILS DOTÉS  
DE LA TECHNOLOGIE Qi



WORKS WITH  
ALL Qi ENABLED  
DEVICES

FINITION RÉSIDANTE  
CUIR SYNTHÉTIQUE



DURABLE SYNTHETIC  
LEATHER FINISHING

PORT USB-C POUR  
CHARGER ET  
RECHARGER



TWO-WAY USB  
PORT TO CHARGE

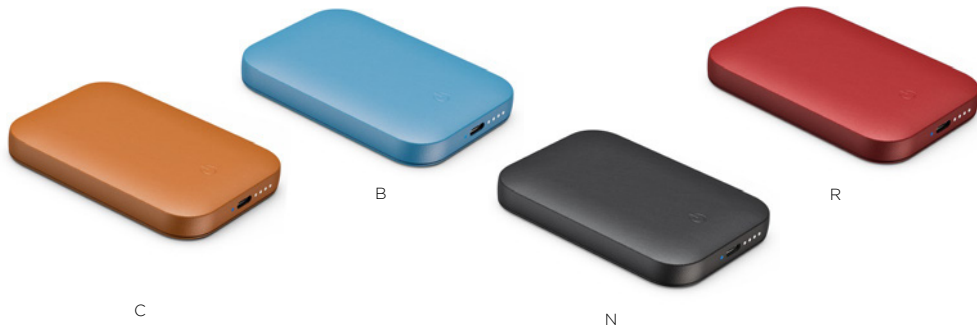

Batterie externe premium de 3000 mAh compatibles Magsafe (iPhone 12 et plus récent) avec connecteur Type-C à double sens - 5W en sortie de charge sans fil Qi et 15W via câble - Compatible avec tous les appareils Qi - Peut charger 2 appareils simultanément - Design compact et finition en cuir synthétique de qualité supérieure - Délivre une charge complète, varie selon le smartphone - Temps de charge : 2h - Rechargeable par USB-C (câble inclus) - Matériaux : Cuir synthétique - ABS.

Premium Magsafe compatible (iPhone 12 and newer) 3000 mAh powerbank with dual way Type-C connector - 5W Qi wireless charging output and up to 15W via cable - Compatible with any Qi devices - Can charge 2 devices simultaneously - Compact design and premium synthetic leather finishing - Delivers one full charge depending on smartphone - Charging time: 2h - Rechargeable via USB-C (cable included) - Material: Synthetic leather - ABS.

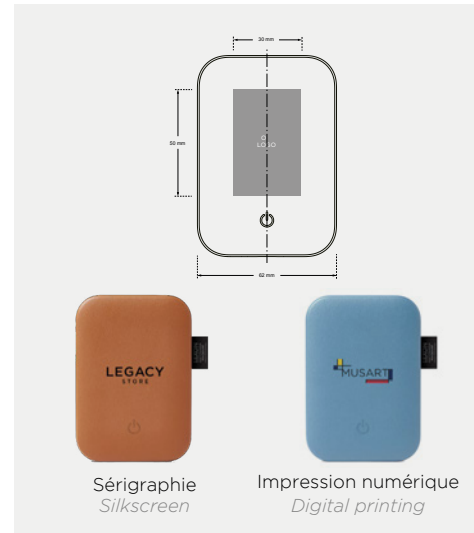

9 x 1.2 x 6.2 cm / P. Brut: 178 g  
3.54 x 0.39 x 2.37" / G.W: 0.39 lbs



Colisage: 40p / Env. 7.6 kg  
Carton: 40p / Approx. 16.75 lbs

# SOFTPOWER WIRELESSBANK

10 000 mAh power bank with built-in wireless charger  
 Batterie externe 10 000 mAh avec chargeur à induction intégré

# SOFTPOWER WIRELESSBANK

Design by Alain Berteau



- BATTERIE EXTERNE  
10000 mAh**



10 000 mAh  
POWER BANK
- CHARGEUR À  
INDUCTION CERTIFIÉ Qi**



Qi-CERTIFIED  
WIRELESS CHARGER
- CHARGE RAPIDE  
15W**



15W  
FAST CHARGING
- FONCTIONNE AVEC TOUS  
LES APPAREILS DOTÉS  
DE LA TECHNOLOGIE Qi**



WORKS WITH  
ALL Qi ENABLED  
DEVICES
- FINITION RÉSISTANTE  
CUIR SYNTHÉTIQUE**



DURABLE SYNTHETIC  
LEATHER FINISHING
- PORT USB-C POUR  
CHARGER ET  
RECHARGER**



TWO-WAY USB  
PORT TO CHARGE  
& RECHARGE

Batterie externe 10 000 mAh avec chargeur à induction certifié Qi - Charge rapide 15W : environ 3h pour une charge complète du smartphone - Compatible avec tous les appareils Qi - Port USB-C bidirectionnel pour charger et se recharger (câble inclus). Matériaux : ABS - PC enveloppé de cuir synthétique.

10 000 mAh power bank with Qi certified wireless charger - 15W fast charging: approx 3h for a full smartphone charge - Compatible with all Qi enabled devices - Dual way USB-C connector for charging and recharging (cable included). Material: ABS - PC wrapped with synthetic leather.

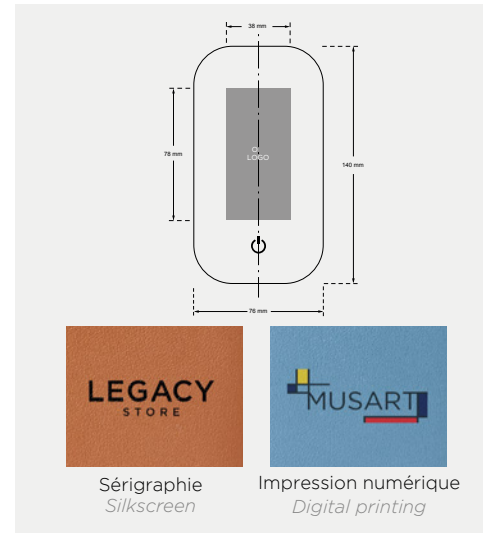

14 x 7,6 x 1,74 cm / P. Brut: 292 g  
 5,5 x 2,99 x 0,69" / G.W: 0,64 lbs

Colisage: 20p / Env. 7.6 kg  
 Carton: 20p / Approx. 16.75 lbs

# POWERSOUND

5 000 mAh wireless power bank with Bluetooth® speaker  
 Batterie externe 5 000 mAh avec chargeur à induction & enceinte Bluetooth® intégrée

# POWERSOUND

Design by Alain Bertheau



AWARDS



- CHARGEUR À INDUCTION Qi 5000 mAh**  
5 000 mAh Qi WIRELESS CHARGER
- FONCTIONNE AVEC TOUS LES APPAREILS DOTÉS DE LA TECHNOLOGIE Qi**  
WORKS WITH ALL Qi ENABLED DEVICES
- ENCEINTE BLUETOOTH® 5W**  
5W BLUETOOTH® SPEAKER
- JUSQU'À 20H D'AUTONOMIE**  
UP TO 20 HOURS PLAYTIME
- RECHARGE ET CHARGE SANS FIL**  
SOLELY WIRELESS CHARGING AND RECHARGING
- FINITION RÉSISTANTE CUIR SYNTHÉTIQUE**  
DURABLE SYNTHETIC LEATHER FINISHING

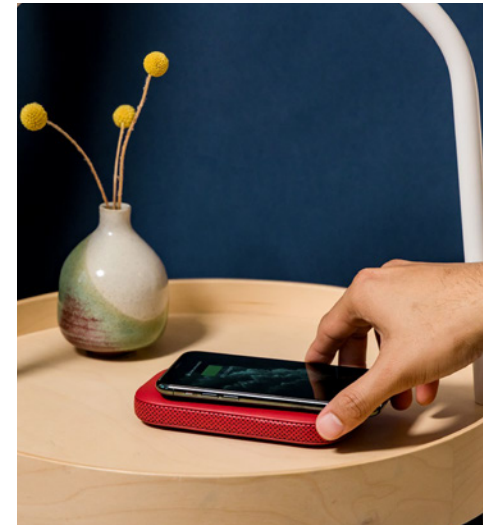

Batterie externe 5 000 mAh et chargeur à induction Qi avec enceinte Bluetooth® intégrée - Chargeur à induction 5W - Compatible avec tous les appareils dotés de la technologie de charge Qi - Enceinte Bluetooth® 3W - Autonomie : jusqu'à 20h - Se recharge et charge par induction, entièrement sans fil - Matériaux : ABS enveloppé de cuir synthétique.

5 000 mAh Qi wireless power bank with Bluetooth® speaker - 5W wireless charger - Compatible with all Qi enabled devices - 3W Bluetooth® speaker - Playtime: up to 20h - Solely wireless charging and recharging - Material: ABS wrapped with synthetic leather.

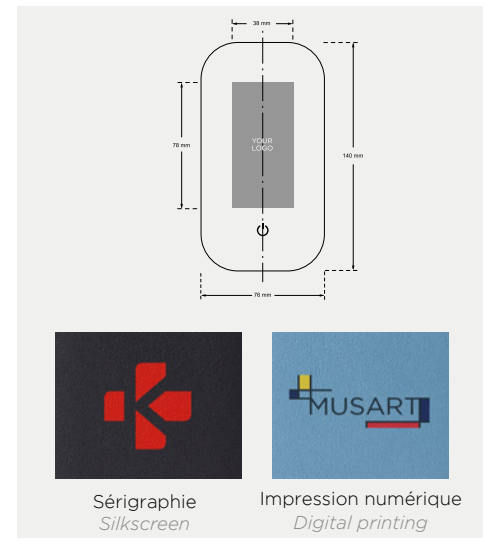

7,6 x 2,3 x 14 cm / P. Brut: 260 g  
 3.03 x 0.94 x 5.59" / G.W: 0.57 lbs

Colisage: 20p / Env. 6.2 kg  
 Carton: 20p / Approx. 13.66 lbs

# OSLO ENERGY+

Wireless charging station with Bluetooth® speaker & microphones  
 Station de charge à induction avec enceinte Bluetooth® & microphones

# OSLO ENERGY+

Design by Manuela Simonelli & Andrea Quaglio



Station de recharge sans fil avec haut-parleur Bluetooth® et microphones - Station de charge à induction 10W certifiée Qi - Enceinte Bluetooth® 5W - Compatible avec les appareils utilisant la technologie Qi - Appels mains-libres - Double microphones avec réduction du bruit ambiant - Indicateur de charge sans fil et LED Bluetooth® - Version Bluetooth® : 5.0 | Distance Bluetooth® : 10m - Rechargeable par USB-C (câble inclus) et sur adaptateur secteur certifié - Quick Charge 3.0 ou un adaptateur secteur USB DC 9V/2A (non inclus). Matériaux : Cuir PU - ABS.

Wireless charging station with Bluetooth® speaker & microphones - 10W Qi wireless charging station - 5W Bluetooth® speaker - Compatible with Qi-enabled devices - Hands-free conference calls - Environment noise-cancelling microphones - Wireless charging & Bluetooth® - LED lights indicator - Bluetooth® version: 5.0 | Bluetooth® distance: 10m - Rechargeable via USB-C (cable included) - Power supply: recommend to use with Quick Charge 3.0 power adapter (not included) or a DC 9V/2 power adapter (not included). Material: PU leather- ABS.

<p><b>CHARGEUR A INDUCTION 10W</b></p> <p>10W WIRELESS CHARGER</p>	<p><b>ENCEINTE BLUETOOTH®</b></p> <p>BLUETOOTH® SPEAKER</p>	<p><b>DOUBLE MICROPHONE</b></p> <p>DUAL MICROPHONE</p>	<p><b>OPTIMISÉ POUR LES CONFÉRENCES AUDIOS</b></p> <p>OPTIMIZED FOR CONFERENCE CALLS</p>	<p><b>RÉDUCTION DU BRUIT AMBIANT</b></p> <p>AMBIANT NOISE CANCELLING</p>	<p><b>FINITION RÉSISTANTE CUIR SYNTHÉTIQUE</b></p> <p>DURABLE SYNTHETIC LEATHER FINISHING</p>
--	---	--	--	--	---



C



DB



N



DR

Technical drawing showing dimensions: Ø 120, 40, 25 mm, 30 mm, 12 mm, 14.5. Includes a 'YOUR LOGO' placeholder.

Sérigraphie  
Silkscreen

Impression numérique  
Digital printing



Ø 12x2,5 cm | P.Brut : 423 g  
 Ø 4.7x0.9" | G.W: 0.93 lbs

Colisage : 20p / 9,04 kg  
 Carton: 20p / 19.9 lbs

LL130

## FINE TUBE POWER BANK 2

3 000 mAh power bank / Batterie externe 3 000 mAh  
Design by Pauline Deltour



BATTERIE EXTERNE  
3000 mAh



3000 mAh  
POWER BANK

PORT  
USB



USB  
PORT

PORT  
USB-C



USB-C  
PORT

FINITION  
ALUMINIUM



ALUMINIUM  
FINISHING

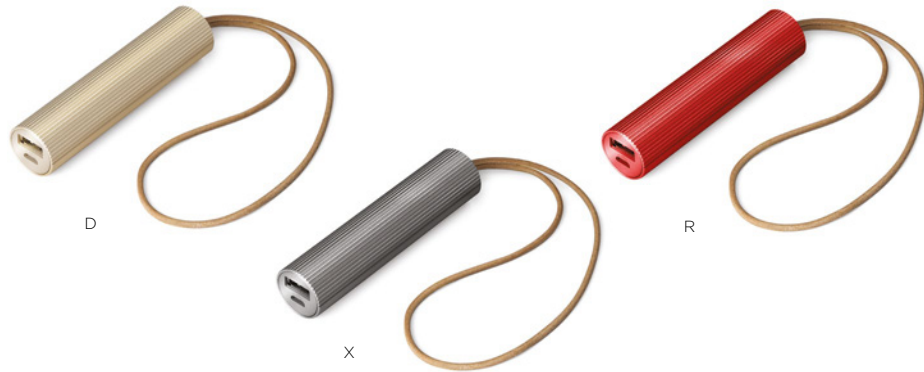

Batterie externe de 3 000 mAh - Port d'entrée USB-C / Port de sortie USB - Matériaux : Aluminium - Cuir. Marquage conseillé : laser - tampographie.

3 000 mAh Power Bank - USB-C input port / USB output port . Material: Aluminum - Leather. Suggested branding: laser - pad print.

Ø2 x 9,5 cm | P. Brut : 93 g  
0.79 x 3.74" | G.W: 0.22 lbs

Colisage : 60 p / 6,3 kg  
Carton: 60 p / 13.4 lbs

LL138

## NOMADAY POWER BANK

3000 mAh power bank with clip / Batterie externe 3 000 mAh avec mousqueton  
Design by Guillaume Delvigne



BATTERIE EXTERNE  
3000 mAh



3000 mAh  
POWER BANK

PORT  
USB



USB  
PORT

PORT  
USB-C



USB-C  
PORT

FINITION  
ALUMINIUM



ALUMINIUM  
FINISHING



Batterie externe de 3 000 mAh - Indicateur LED - Mousqueton intégré 2 ports : USB-A et USB-C - Matériaux : Mousqueton en alliage de zinc - Corps en aluminium. Marquage conseillé : sérigraphie-laser.

3 000 mAh Power Bank - LED indicator - Built-in hook handle 2 ports: USB-A and USB-C - Material: Zinc hook - Aluminum body. Suggested branding: silkscreen-laser.

Ø3,5 x 13,3 cm | P.Brut : 156 g  
Ø1.38 x 5.24" | G.W: 0.34 lbs

Colisage : 50 p / 9,25 kg  
Carton: 50 p / 20.4 lbs

LL161

NEW

# PEAS POWER

Power strip with dual USB-C ports / Multiprise quadruple avec double port USB-C  
Design by LEXON Studio

LEXON  
STUDIO

LL160

NEW

# TELA

3-in-1 magnetic wireless charging station with LED lamp / Station de charge sans fil magnétique 3-en-1 avec LED intégrée. Design by Manuela Simonelli & Andrea Quaglio

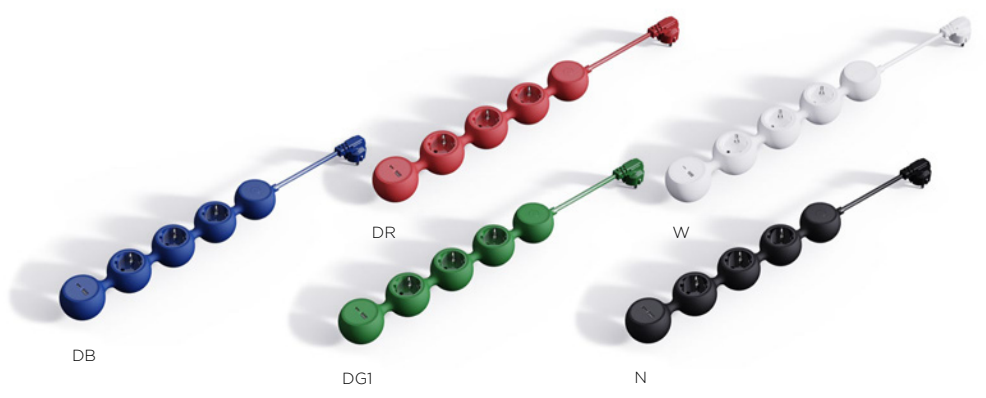
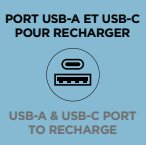

Multiprise quadruple avec double port USB-C - 4 prises pour les appareils électroniques tels que les ordinateurs, les smartphones ou d'autres appareils ménagers - Bouton interrupteur - Ports USB-A et USB-C 30W - Chargement simultané de plusieurs appareils - Protection contre les surtensions - Matériaux : PC. Marquage conseillé : laser - tampographie.

Power strip with dual USB-C ports - 4 AC outlets for electronic devices such as computers, smartphones or other household devices - Power switch button - 30W USB-A & USB-C ports - Charge multiple devices simultaneously - Surge protection - Material: PC. Suggested branding: laser - pad print.

TBD I.P.Brut : TBD  
TDB I.G.W:TBD

Colisage: Informations à confirmer  
Carton: To be confirmed

Station de charge sans fil magnétique 3-en-1 avec LED intégrée - Pour iPhone + Apple Watch + AirPods - Connexion rapide et sécurisée en mode portrait ou paysage - Charge jusqu'à 15W pour iPhone 12 ou plus récent - Surface de recharge sur le dessus compatible avec la plupart des téléphones et appareils qui prennent en charge la recharge sans fil - Lumière blanche froide ou chaude + 7 couleurs - Variateur d'intensité - Contrôle tactile - Alimentation : par USB-C (câble inclus) et un adaptateur d'alimentation certifié Quick Charge 3.0 ou un adaptateur d'alimentation USB DC 9V-2A (non inclus). Matériaux : Aluminium - ABS. Marquage conseillé: laser - tampographie.

3-in-1 magnetic wireless charging station - For iPhone + Apple Watch + AirPods - Fast and secure connection in portrait or landscape mode - Charge up to 15W for iPhone 12 or newer - One charging surface on top compatible with most phones and devices that support wireless charging - Cool or warm white light + 7 colors - Dimmer - Touch control - Power supply: via USB-C (cable included) and a Quick Charge 3.0 certified power adapter or a USB DC 9V-2A power adapter (not included). Material: Aluminum - ABS. Suggested branding: laser - pad print.

**WORK**  
TRAVAILLER



**WORK** TRAVAILLER

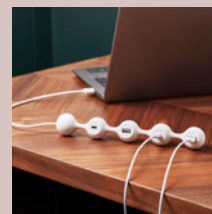

**PEAS  
HUB-C**

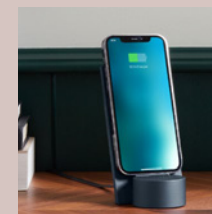

**CITY  
ENERGY  
PRO**

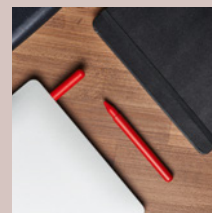
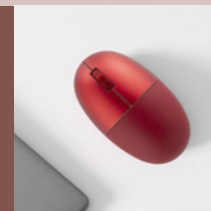

**C-PEN**

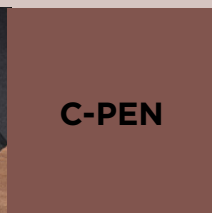

**C-PEN  
STYLUS**

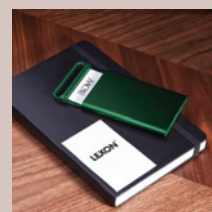
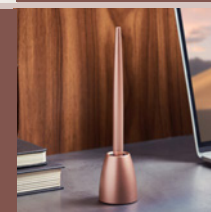
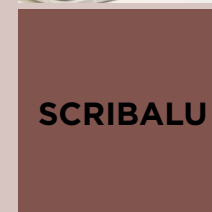
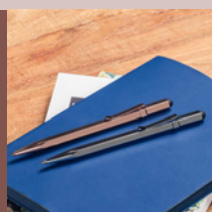

**NOMADAY  
CARD**

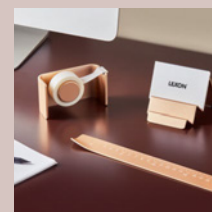

**CITY  
COLLECTION**

**PEAS HUB-C**

Hub with USB-C connector for 2 USB-A ports + 2 USB-C ports  
 Hub avec connectique USB-C pour 2 ports USB-A + 2 ports USB-C

**PEAS HUB-C**

Design by Valentina & Simone Spalvieri



Hub avec une connectique USB-C pour 2 ports USB-A + 2 ports USB-C - Câble intérieur cuivre -  
 Matériaux : Gomme siliconée.

Hub with USB-C connector for 2 USB-A ports + 2 USB-C ports - Copper inside cable. Material: Silicone rubber.



Ø 3,2 x 22,8 cm | P. Brut : 185 g  
 Ø1.30 x 8.98»/ G.W: 00.41 lbs



Colisage : 40p / 6,1 kg  
 Carton: 40p / 13.45 lbs

# CITY ENERGY PRO

Wireless charging station with Bluetooth® speaker & microphones  
 Station de charge à induction avec enceinte Bluetooth® & microphones

# CITY ENERGY PRO

Design by Manuela Simonelli & Andrea Quaglio



- CHARGEUR SANS FIL RAPIDE 10W**  
10W WIRELESS FAST CHARGER
- ENCEINTE BLUETOOTH®**  
BLUETOOTH® SPEAKER
- DOUBLE MICROPHONE**  
DUAL MICROPHONE
- OPTIMISÉ POUR LES CONFÉRENCES AUDIOS**  
OPTIMIZED FOR CONFERENCE CALLS
- RÉDUCTION DU BRUIT AMBIANT**  
AMBIANT NOISE CANCELLING
- FINITION ALUMINIUM & CUIR SYNTHÉTIQUE**  
ALUMINUM & SYNTHETIC LEATHER FINISHING



Station de recharge sans fil avec haut-parleur et Microphones Bluetooth® - Station de charge sans fil Qi 10W - Enceinte Bluetooth® - Compatible avec tous les smartphones compatibles à la recharge sans fil Qi - Audioconférences mains-libres - 2 microphones avec technologie de réduction du bruit ambiant - Se recharge sans fil - Voyants lumineux LED Bluetooth® - Version Bluetooth® : 5.0 | Distance Bluetooth® : 10m - Connexion : USB-C (câble inclus). Matériaux : Cuir synthétique - ABS - Aluminium.

Wireless charging station with Bluetooth® speaker & Microphones - 10W Qi wireless charging station - Bluetooth® speaker - Compatible with all Qi-enabled smartphones - Hands-free conference calls - Environment noise-cancelling microphones - Wireless charging & Bluetooth® LED lights indicator - Bluetooth® version: 5.0 | Bluetooth® distance: 10m - Connection: USB-C (cable included). Material: Synthetic leather - ABS - Aluminum.

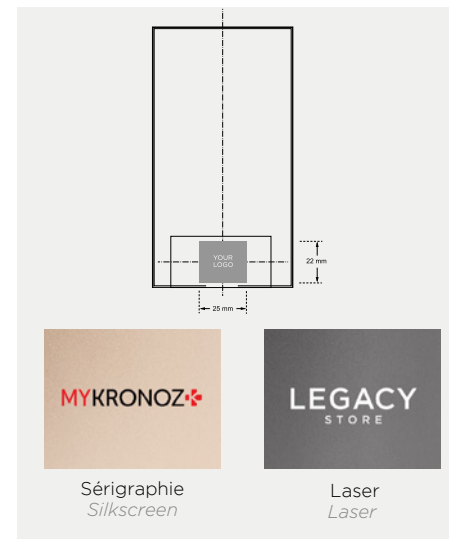

Surface sans fil 7,9 x 3,7 x 14,3 cm | P.Brut : 400 g  
 Wireless surface 3.11 x 1.46 x 5.63" | G.W: 0.88 lbs

Colisage : 20p/8,6 kg  
 Carton: 20p/18.9 lbs

# CITY LIGHT PRO

Desk lamp with built-in speaker / microphones & wireless charger  
 Lampe de bureau avec enceinte / microphones & chargeur à induction intégré

# CITY LIGHT PRO

Design by Manuela Simonelli & Andrea Quaglio



- LAMPE LED



LED LIGHT
- 9 COULEURS D'AMBIANCE



9 COLORS LIGHT
- VARIATEUR D'INTENSITÉ



DIMMER
- COMMANDES TACTILES



TOUCH CONTROLS
- DOUBLE MICROPHONE



DUAL MICROPHONE
- ENCEINTE BLUETOOTH



BLUETOOTH SPEAKER
- CHARGEUR À INDUCTION



WIRELESS CHARGER
- BATTERIE RECHARGEABLE



RECHARGEABLE BATTERY
- PORT USB-C



USB-C PORT

Lampe de bureau avec haut-parleur Bluetooth® et microphones - Station de charge sans fil Qi 10W - Enceinte Bluetooth® - Compatible avec tous les smartphones compatibles à la recharge sans fil Qi - Audioconférences mains-libres - 2 microphones avec technologie de réduction du bruit ambiant - Batterie intégrée - Autonomie : 24h pour l'éclairage seul - Connexion : USB-C (câble inclus). Matériaux : ABS - Cuir synthétique.

Wireless charging desk lamp with Bluetooth® speaker & microphones - 10W Qi wireless charging station - Bluetooth® speaker - Compatible with all Qi-enabled smartphones - Hands-free conference calls - Ambient noise-cancelling microphones - Operating with touch controls - Ideal position for video calls - Rechargeable built-in battery - Battery life: Up to 24h for lighting mode only - Charging time: 2h - Connection: USB-C (cable included). Material: ABS - Synthetic leather.

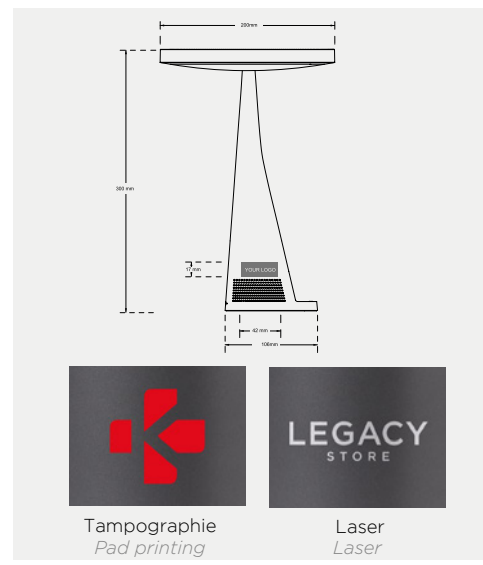

23 x 30 x 6.9 cm / P. Brut: 640 g  
 9.05 x 12 x 2.72" / G.W: 1.41 lbs



Colisage: Informations à confirmer  
 Carton: To be confirmed

# MUSO

Bluetooth® wireless mouse / Souris sans fil Bluetooth®

# MUSO

Design by Manuela Simonelli & Andrea Quaglio

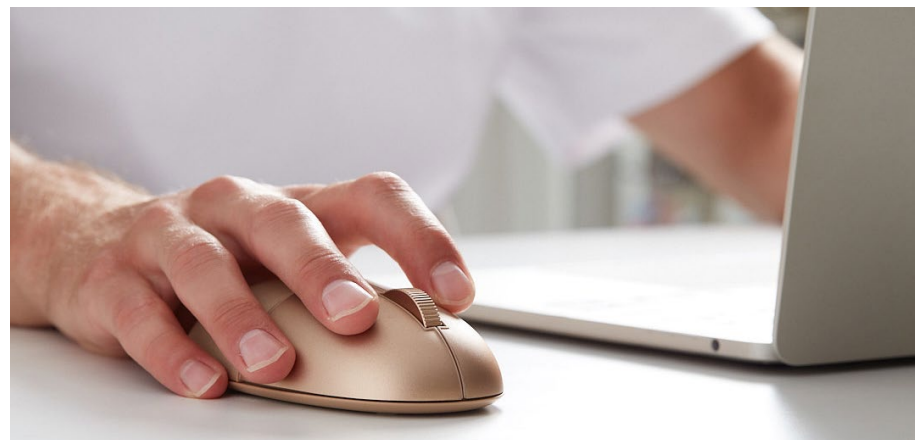

- DESIGN  
ERGONOMIQUE**



ERGONOMIC  
DESIGN
- CLIC  
SILENCIEUX**



SILENT  
CLICK
- COMPATIBLE AVEC PLUSIEURS  
SYSTEMES D'EXPLOITATION**



COMPATIBLE WITH  
MULTIPLE OS
- JUSQU'À 6 MOIS  
D'AUTONOMIE**



UP TO 6 MONTHS  
BATTERY LIFE
- PORT DE  
CHARGE USB-C**



USB-C  
CHARGING PORT
- RECHARGEABLE  
PAR INDUCTION**



WIRELESSLY  
RECHARGEABLE
- FINITION  
ALUMINIUM**



ALUMINUM  
FINISHING

Souris Bluetooth® sans fil et compacte avec pointeur laser - Deux boutons et une molette de défilement - Haute précision sur de multiples surfaces - Ambidextre - Ergonomie et design parfait - Batterie rechargeable - Autonomie : Jusqu'à 6 mois - Temps de charge : 3h - Rechargeable par USB-C (câble inclus). Matériaux : Cuir synthétique - ABS - Aluminium.

Compact Wireless mouse with premium finishing - Dual buttons and precise scroll wheel - High precision on multiple surfaces - Ambidextrous - Perfect ergonomic design - Rechargeable battery - Battery life: Up to 6 months - Charging time: 3h - Rechargeable via USB-C (cable included). Material: Synthetic leather - ABS - Aluminium.

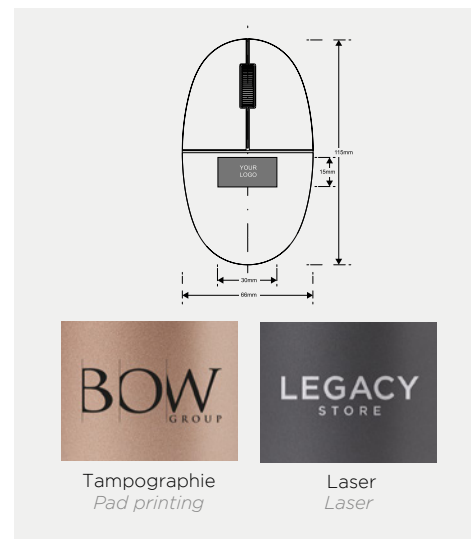

11,5 x 6,7 x 3,1 cm / P. Brut : 150 g  
4,53 x 2,59 x 1,22" / G.W: 0,33 lbs

Colisage: 20p / 3,8 kg  
Carton: 20p/ 8,38 lbs

LS101

**C-PEN**

Ballpoint pen with 32Gb USB-C drive / *Stylo bille avec clé USB-C 32Go*  
Design by Alain Berteau

AWARD



reddot winner 2021



STYLO À BILLE  
À ENCRE NOIRE  
RECHARGE UNIVERSELLE



BLACK INK  
BALLPOINT PEN  
UNIVERSAL REFILL

CONNECTEUR  
USB-C



USB-C  
DRIVE

CAPACITÉ  
DE 32GO



32GB  
CAPACITY

COMPATIBLE AVEC  
LES ORDINATEURS, TABLETTES  
ET SMARTPHONES USB-C



COMPATIBLE WITH USB-C  
COMPUTERS, TABLETS  
AND SMARTPHONES



N



WG



DR



DB



PF



YF

Stylo bille avec clé USB-C 32Go - Recharge universelle Connecteur USB-C - Capacité de 32Go - Stockez jusqu'à 4 000 photos, 7000 chansons ou 40h de vidéos - Compatible : Windows 7,8 & 10 / Max OS X v10.6 et supérieur. Matériaux : Acier inoxydable pour clip - Corps principal en ABS.

*Ballpoint pen with 32GB USB-C drive - Universal refill - USB-C connector - Capacity of 32GB - Save up to 4,000 pictures, 7,000 songs or 40h of video - Compatible: Windows 7,8 & 10 / Mac OS X v10.6 and higher - Material: Stainless steel for clip - ABS main body.*

Ø1,1 x 15 cm | P.Brut : 71,8 g  
Ø0,43 x 5,90" | G.W: 0,16 lbs

Colisage : 50 p / 4,3 kg  
Carton: 50 p / 9,6 lbs

LS102

**C-PEN STYLUS**

Stylus with 32Gb USB-C drive / *Stylet avec clé USB-C 32Go*  
Design by Alain Berteau



STYLET POUR APPAREILS  
AVEC ÉCRAN TACTILE



STYLUS FOR TOUCHSCREEN  
DEVICES

CONNECTEUR  
USB-C



USB-C  
DRIVE

CAPACITÉ  
DE 32GO



32GB  
CAPACITY

COMPATIBLE AVEC  
LES ORDINATEURS, TABLETTES  
ET SMARTPHONES USB-C



COMPATIBLE WITH USB-C  
COMPUTERS, TABLETS  
AND SMARTPHONES



N



WG



DR



DB

Stylet avec mémoire flash USB-C - Recharge universelle - Connecteur USB-C - Capacité de 32 Go - Compatible : Windows 7,8 & 10 / Max OS X v10.6 et supérieur. Matériaux : Acier inoxydable pour clip - Corps principal en ABS.

*Ballpoint pen with 32GB USB-C drive - Universal refill - USB-C connector - Capacity of 32GB - Save up to 4,000 pictures, 7,000 songs or 40h of video - Compatible: Windows 7,8 & 10 / Mac OS X v10.6 and higher - Material: Stainless steel for clip - ABS main body.*

Ø 1,1 x 15,6 cm | P. Brut : 70 g  
Ø 0,43 x 6,14" | G.W: 0,15 lbs

Colisage : 50p / 4,1 kg  
Carton: 50p / 9,04 lbs

**BEE 2**

Twisting ballpoint pen & stylus / *Stylo à bille rotatif & stylet*  
Design by Lexon Studio



**SCRIBALU**

Rollerball pen on base / *Stylo roller sur socle*  
Design by Lexon Studio



Stylo à bille rotatif 2-en-1 / *Stylet* - Recharge universelle - Matériaux : Laiton. Marquage conseillé : sérigraphie - laser.

2-in-1 twist ballpoint pen / *stylus* - Universal refill - Material: Brass. Suggested branding: silkscreen - laser.

Ø 0,8 x 14,2 cm | P. Brut : 65 g  
Ø 0.3 x 5.6" | G.W: 0.14 lbs

Colisage : 100 p/5,7 kg | s/c : 50 p/3 kg  
Carton: 100 p/12.57 lbs | i/c: 50 p/16 oz

Colors on request / *Couleurs sur demande*

Stylo roller sur socle - Recharge universelle - Matériaux : Aluminium. Marquage conseillé : sérigraphie - laser.

Rollerball pen on a base - Universal refill - Material: Aluminum. Suggested branding: laser - silkscreen.

Ø 4 x 18 cm | P. Brut : 170 g  
Ø 1.6 x 7» | G.W: 0.37 lbs

Carton: 50 p/8,9 kg | i/c: 25 p  
Carton: 50 p/19.8 lbs | i/c: 25 p

**NOMADAY CARD**

Case for 15 business cards / Étui pour 15 cartes de visite

Design by Guillaume Delvigne



DG1



DR



N



DB



D



X

Étui pour 15 cartes de visite - Matériaux : Aluminium - ABS. Marquage conseillé : sérigraphie - laser.

Business card case for 15 cards - Material: Aluminum - ABS. Suggested branding: Silkscreen - Laser.

6,4 x 1 x 11,4 cm | P. Brut : 75 g  
2.52 x 0.39 x 4.49" | G.W: 0.16 lbs

Colisage : 60 p/ 5,4 kg | s/c: 20 p  
Carton: 60 p/ 11.9 lbs | i/c: 20 p



# CITY COLLECTION

Design by Manuela Simonelli & Andrea Quaglio

# CITY COLLECTION

Design by Manuela Simonelli & Andrea Quaglio

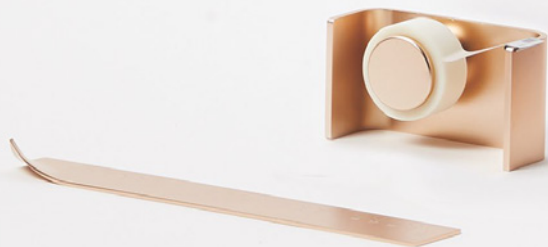

**LD135  
RULER**



Règle de 20 cm - Matériaux :  
aluminium. Marquage conseillé :  
sérigraphie - laser.

*20 cm ruler - Material:  
Aluminum. Suggested  
branding: silkscreen - laser.*

23,5 x 3,2 x 0,9 cm / P. Brut :  
63 g / Colisage : 100p / 7.5 kg  
9.2 x 1.2 x 0.3" / G.W: 0.14 lbs /  
Carton: 100p / 16.5 lbs



**LD139  
TAPE DISPENSER**



Dévidoir de ruban adhésif -  
Rouleau adhésif mat fourni  
- Matériaux : aluminium.  
Marquage conseillé :  
sérigraphie - laser.

*Desk tape dispenser - Matt  
tape included - Material:  
Aluminum. Suggested  
branding: silkscreen - laser.*

9,7 x 4 x 5,5 cm / P. Brut : 181 g /  
Colisage : 40p / 8 kg  
3.8 x 1.6 x 2.1" / G.W: 0.4 lbs /  
Carton : 40p / 17.7 lbs



**LD138  
DESK TRAY**



Vide poche - 4 compartiments  
- Matériaux : aluminium.  
Marquage conseillé :  
sérigraphie - laser - impression  
numérique.

*Round desk tray -  
4 compartments - Material:  
Aluminum. Suggested  
branding: silkscreen - laser -  
digital printing.*

Ø 10,2 x 2,9 cm / P. Brut : 140 g  
/ Colisage : 40p / 7,5 kg  
Ø 4 x 1.1" / G.W: 0.31 lbs /  
Carton: 40p / 16.5 lbs



**LD137  
CARD STAND**



Support pour cartes de  
visite - Matériaux : aluminium.  
Marquage conseillé :  
sérigraphie - laser.

*Business card holder  
- Material: Aluminum.  
Suggested branding:  
silkscreen - laser.*

10,3 x 7,9 x 5,4 cm / P. Brut : 84 g  
/ Colisage : 40p / 5 kg  
4 x 3.1 x 2.1" / G.W: 0.2 lbs /  
Carton: 40p / 10.8 lbs



**LD140  
PEN CUP**

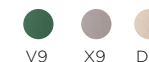

Pot à crayons - Matériaux  
: aluminium. Marquage  
conseillé : sérigraphie - laser.

*Pen cup - Material: Aluminum.  
Suggested branding:  
silkscreen - laser.*

Ø 7 x 8,8 cm / P. Brut : 153 g /  
Colisage : 40p / 7,6 kg  
Ø 2.7 x 3.4" / G.W: 0.34 lbs /  
Carton: 40p / 17 lbs



**LD14  
CARD BOX**



Étui pour 20 cartes de visite -  
Matériaux : aluminium anodisé.  
Marquage conseillé : sérigraphie  
sur laser - embossage en  
fabrication spéciale.

*Business card case for  
20 cards - Material: Anodised  
aluminum. Suggested branding:  
silkscreen - laser - special  
production embossing.*

9,3 x 6,1 x 0,9 cm / P. Brut : 38 g /  
3 kg / Colisage : 300p / 12,840 kg  
3.7 x 2.4 x 0.3" / G.W: 0.1 lbs /  
Carton: 300p / 28 lbs

**MOVE**  
*SE DÉPLACER*



**MOVE** *SE DÉPLACER*

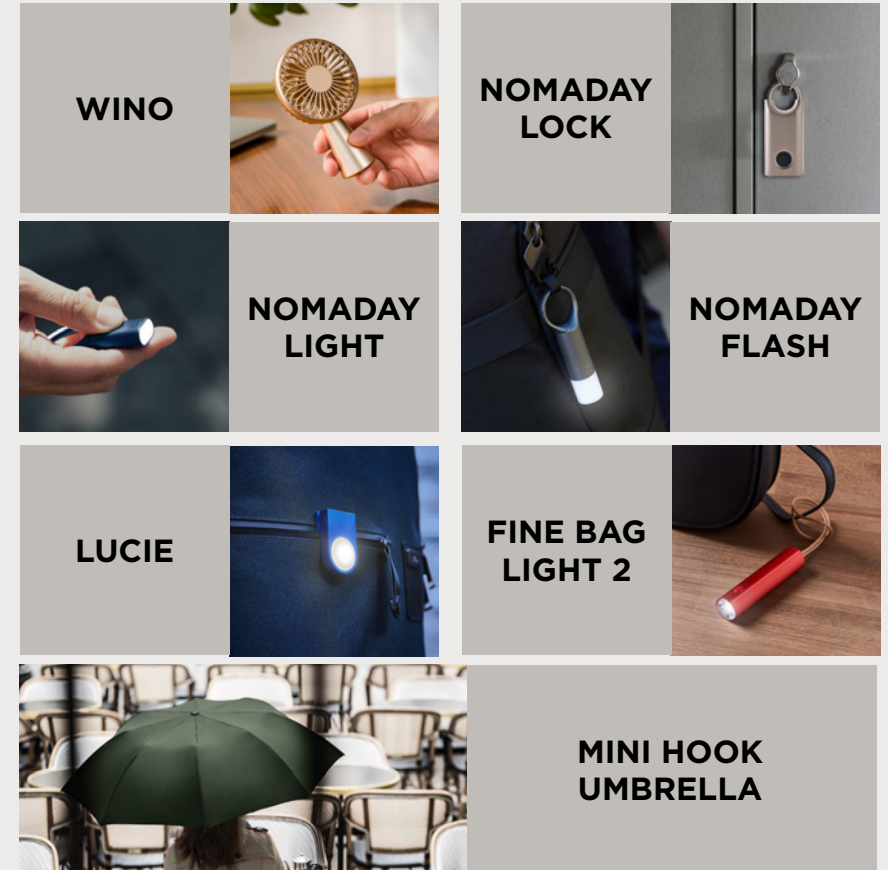

# WINO

Mini portable fan / Mini ventilateur portable



3 VITESSES  
AJUSTABLES



3 ADJUSTABLE  
SPEEDS

PALES ULTRA  
SILENCIEUSES



ULTRA-QUIET  
BLADES

JUSQU'À 5H  
D'AUTONOMIE



UP TO 5H  
BATTERY LIFE

RECHARGEABLE  
PAR INDUCTION



WIRELESSLY  
RECHARGEABLE

RECHARGEABLE  
PAR USB-C



RECHARGEABLE  
VIA USB-C

BASE EN  
ALUMINIUM



ALUMINIUM  
BASE



New colors / Nouvelles couleurs

# WINO

Design by Manuela Simonelli & Andrea Quaglio

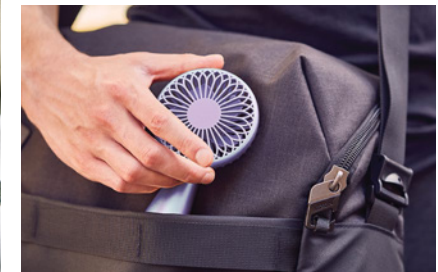

Mini ventilateur portable avec recharge par induction - 3 vitesses de ventilation - Pales ultra silencieuses - Jusqu'à 5h d'autonomie - Temps de charge : 2h - Rechargeable par induction - Port USB-C - Matériaux : base en aluminium & tête en ABS.

Mini hand-held fan with wireless charge - 3 Airflow speeds - Ultra-quiet blades - Up to 5h battery life - Charging time: 2h - Wirelessly rechargeable - USB-C port - Material: Aluminum base & ABS head.

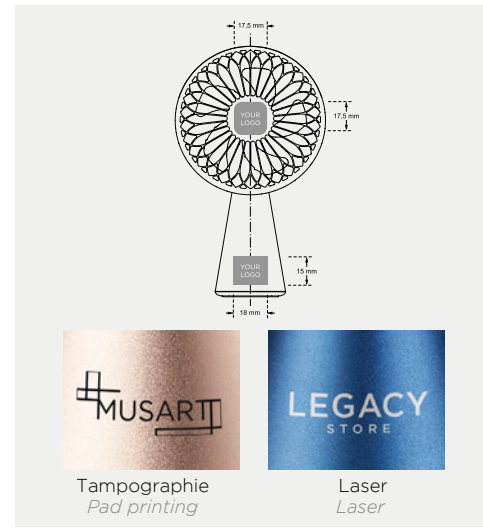

13,2 x 4,8 x 7,9 cm | P. Brut : 220 g  
5.19 x 1.88 x 3.11" | G.W: 0.5 lbs



Colisage : 36p/7,96 kg  
Carton: 36 p/15.4 lbs

# NOMADAY LOCK

Biometric fingerprints padlock / Cadenas biométrique à empreintes digitales

# NOMADAY LOCK

Design by Guillaume Delvigne

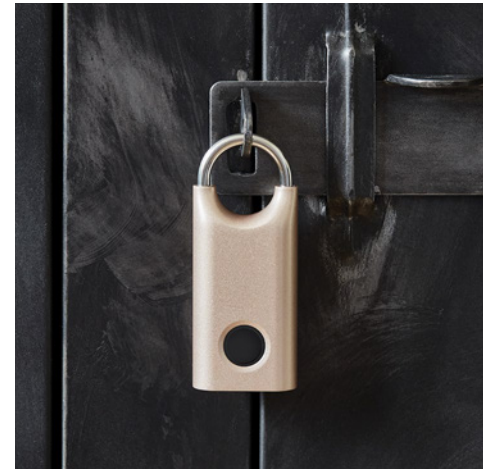

- OUVERTURE EN MOINS DE 0.5 SEC**

**0.5"**

UNLOCKING IN LESS THAN 0.5 SEC
- ENREGISTRE JUSQU'À 10 EMPREINTES DIFFÉRENTES**

STORE UP TO 10 DIFFERENT FINGERPRINTS
- RÉSISTANT À LA PLUIE IP65**

IP65 RAIN-PROOF
- JUSQU'À 12 MOIS D'AUTONOMIE**

**12**

UP TO 12 MONTHS BATTERY LIFE
- RECHARGEABLE PAR USB-C**

RECHARGEABLE VIA USB-C

Cadenas biométrique à empreintes digitales - Usage intérieur/extérieur - Ouverture en moins de 0.5 seconde - Enregistre jusqu'à 10 empreintes différentes - Indicateur LED - Autonomie : jusqu'à 3000 déverrouillages après une charge complète / Autonomie en veille : jusqu'à 12 mois - Temps de charge : 1h30 - Rechargeable par USB-C (câble inclus) - Résistance à l'eau : IP65 Matériaux : Bague en acier inoxydable et corps en alliage de zinc.

Biometric fingerprints padlock - Indoor/Outdoor use - Unlocking in less than 0.5 second - Stores up to 10 different fingerprints - LED indicator - Battery life: up to 3000 unlock times after full charge / Stand by time: up to 12 months - Charging time: 1.5h - Rechargeable via USB-C (cable included) - Water resistance: IP65 - Material: Stainless steel ring and Zinc alloy body.

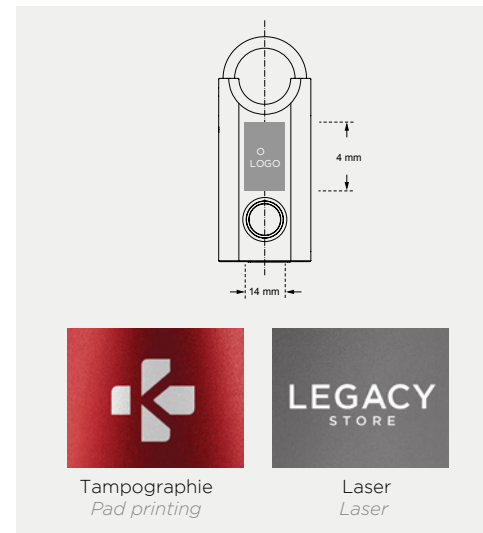

3,2 x 1,4 x 7,6 cm | P.Brut : 140 g  
1.25 x 0.55 x 2.99" | G.W: 0.31 lbs

Colisage : 40p/6.38 kg | s/c: 20p  
Colisage: 40 p/ 14.1 lbs | s/c: 20

LL136

# NOMADAY LIGHT

Mini LED torch keyring with clip / Porte-clés mousqueton avec mini torche LED  
Design by Guillaume Delvigne



- LUMIÈRE LED BLANCHE**  
WHITE LED LIGHT
- VISIBLE JUSQU'À 50 M**  
VISIBLE UP TO 50M
- MOUSQUETON INTÉGRÉ**  
BUILT-IN CLIP
- JUSQU'À 1H D'AUTONOMIE**  
UP TO 1H BATTERY LIFE
- RECHARGEABLE PAR USB-C**  
RECHARGEABLE VIA USB-C
- FINITION ALUMINIUM**  
ALUMINIUM FINISHING

LL137

# NOMADAY FLASH

Wearable LED lamp with clip / Lampe LED de signalisation avec mousqueton  
Design by Guillaume Delvigne



- LED ROUGE OU BLANCHE 4 MODES D'ÉCLAIRAGE**  
RED OR WHITE LED WITH 4 LIGHTING MODES
- VISIBLE JUSQU'À 200 M**  
VISIBLE UP TO 200M
- MOUSQUETON INTÉGRÉ**  
BUILT-IN CLIP
- JUSQU'À 12H D'AUTONOMIE**  
UP TO 12H BATTERY LIFE
- RECHARGEABLE PAR USB-C**  
RECHARGEABLE VIA USB-C
- FINITION ALUMINIUM**  
ALUMINIUM FINISHING
- IPX4 HAUTE RÉSISTANCE À LA PLUIE**  
HIGH RESISTANCE RAIN-PROOF IPX4



Porte-clés mousqueton avec mini torche LED - Lumière visible jusqu'à 50 mètres - Temps de charge : 1h - Rechargeable par USB-C (câble inclus) - Matériaux : ABS - Alliage de zinc - Acier inoxydable. Marquage conseillé : laser - sérigraphie.

Mini LED torch keyring with hook - Visible light up to 150 feet - Charging time: 1h - Rechargeable via USB-C (cable included) - Material: ABS - Zinc Alloy - Stainless steel. Suggested branding: laser - pad print.

3,2 x 1 x 6 cm | P.Brut : 62 g  
1,25 x 0,39 x 2,36" | G.W: 0,14 lbs

Colisage : 80p/5,6 kg | s/c: 40p  
Colisage: 80 p/ 12,3 lbs | s/c: 40



Lampe LED de signalisation avec mousqueton - Lumière rouge ou blanche Fixe ou clignotante - Résistance à la pluie IPX4 - Lumière visible jusqu'à 200 mètres - Autonomie : 12h - Temps de charge : 1h30 - Rechargeable par USB-C (câble inclus) - Matériaux : ABS - Alliage de zinc - Acier inoxydable. Marquage conseillé : laser - sérigraphie.

Wearable LED lamp with clip - Red or white light - Fixed or blinking - IPX4 Rain resistant - Visible light up to 600 feet - Battery life: 12h - Charging time: 1.5h - Rechargeable via USB-C (cable included) - Material: ABS - Zinc Alloy - Stainless steel. Suggested branding: laser - pad print.

3,2 x 1,8 x 10 cm | P.Brut : 115 g  
1,25 x 0,70 x 3,93" | G.W: 0,25 lb

Colisage : 40p/5,4 kg | s/c: 20p  
Colisage: 40 p/ 14,1 lbs | s/c: 20

LL121

## LUCIE

Wearable LED clip / *Clip LED de signalisation*  
Design by Yoann Jacquon



LL129

## FINE BAG LIGHT 2

LED bag light / *Lampe LED pour sac à main*  
Design by Pauline Deltour



LAMPE  
LED



LED  
LIGHT

VISIBLE  
JUSQU'À 150 M



VISIBLE  
UP TO 150M

CLIP COMPACT  
ET ULTRA STABLE



COMPACT &  
SECURE CLIP

RÉSISTANCE  
À LA PLUIE



RAIN  
RESISTANT

RECHARGEABLE  
PAR USB-C



RECHARGEABLE  
VIA USB-C

LAMPE  
LED



LED  
LIGHT

RECHARGEABLE  
PAR USB-C



RECHARGEABLE  
VIA USB-C

FINITION  
ALUMINIUM



ALUMINIUM  
FINISHING



B

D

X

R

N



D

X

R

Clip LED de signalisation - Lumière blanche ou rouge - Fixe ou clignotante - Rechargeable - Résistance à la pluie IPX4 - Lumière visible jusqu'à 150 mètres - Autonomie : jusqu'à 12h - Temps de charge : 2h - Rechargeable par USB-C (câble inclus). Matériaux : Aluminium - ABS. Marquage conseillé : sérigraphie.

*Wearable LED clip - Red or white light - Fixed or blinking Rechargeable Rain resistance IPX4 - Visible light up to 500 feet Battery life: up to 12h - Charging time: 2h - Rechargeable via USB-C (cable included) Material: Aluminum- ABS. Suggested branding: silkscreen.*

3,1 x 1,3 x 4,8 cm | P.Brut : 57 g  
1,22 x 0,51 x 1,89" | G.W: 0,12 lbs

Colisage : 80p/5,6 kg | s/c: 40p  
Colisage: 80 p/ 12,3 lbs | s/c: 40

Lampe pour sac à main - LED ultra lumineuse - Autonomie : jusqu'à 4 heures après une charge complète - Autonomie en veille : jusqu'à 6 mois - Temps de charge : 1,5h - Rechargeable par USB-C (câble inclus) - Matériaux : Aluminium - ABS - Cuir. Marquage conseillé : laser - tampographie.

*Bag light - Super bright LED - Battery life: up to 4 hours after a full charge - Standby time: up to 6 months - Charging time: 1,5h - Rechargeable via USB-C (cable included). Material: Aluminum - ABS - Leather. Suggested branding: laser - pad print.*

Ø2,2 x 9,6cm | P.Brut : 107 g  
Ø0,87 x 3,78" | G.W: 0,23 lbs

Colisage : 50p/5,6 kg  
Carton: 50 p/12,3 lbs



# MINI HOOK UMBRELLA

Design by Theo Williams



M1 LP LL



R O1 J8 B LB1 K9 N6 G3

Parapluie pliable 2 sections - Poignée mousqueton - Matériaux : Axe aluminium - Toile en rPET - Poignée ABS gomme. Marquage conseillé : sérigraphie.

Foldable umbrella 2 sections - hook handle - Material: Aluminum shaft - rPET fabric - ABS rubber handle. Suggested branding: silkscreen.

Fermé Ø 5 x 51 cm / Ouvert Ø 122 x 50 cm | P. Brut : 410 g  
 Closed Ø 1.96 x 20.07" / Open Ø 48.03 x 20.07" | G.W: 0.94 lbs

Colisage : 24 p/11,240 kg | s/c: 12p  
 Colisage: 24 p/ 24.8 lbs | s/c: 12

New colors / Nouvelles couleurs



# CARRY TRANSPORTER



## YOU CARRY, WE CARE

At Lexon, we are committed to offer durable solutions by sourcing innovative and responsible materials.

2024 marks the beginning of our move towards sustainability as we will progressively shift our entire bag category to be made in environmentally-friendly fabrics such as rPET.

*Chez Lexon, nous nous engageons à offrir des solutions durables en sélectionnant des matériaux innovants et responsables. 2024 marque le début de notre évolution vers la durabilité ; la transformation de l'ensemble de notre catégorie bagagerie est en marche, avec pour objectif de fabriquer toutes nos collections dans des tissus respectueux de l'environnement tels que le rPET.*

# CARRY TRANSPORTER



ONE+

PREMIUM+



TRACK

CHALLENGER



EVE

TERA



PEANUT

PACKABLE





**LC2806  
TECH POUCH**



**LC2807  
TECH ORGANIZER**



**LC2808  
MINI POUCH**



Pochette à bandoulière pour smartphone avec 2 compartiments

11 x 2,5 x 20 cm / P. Brut: 120 g

*Sling pouch for smartphone with 2 compartments*

4.33 x 0.98 x 7.87" / G.W: 0.26 lbs

Pochette pour accessoires électroniques - Ouverture à plat

19 x 8,5 x 11 cm / P. Brut: 100 g

*Pouch for electronic accessories - Flat opening*

7.48 x 3.35 x 4.33" / G.W: 0.22 lbs

Pochette dotée d'une dragonne

21 x 5 x 12 cm / P. Brut: 80 g

*Pouch with wrist strap*

8.27 x 1.97 x 4.72" / G.W: 0.18 lbs

**LC2800 BACKPACK / LC2803 DOUBLE BACKPACK**



N



B



G



R

15"

16"

Sac à dos - Compartiment pour ordinateur jusqu'à 16" - Capacité: 14 L

28 x 13 x 38 cm / P. Brut: 550 g / Colisage: 24 pcs / 13.2 kg

Sac à dos double - Compartiment pour ordinateur jusqu'à 16" - Capacité: 15 L

28 x 14 x 38 cm / P. Brut: 560 g / Colisage: 24 pcs / 13.4 kg

*Backpack - Compatible up to 16" laptop - Capacity: 14 L*

11.02 x 5.12 x 14.96" / G.W: 1.21 lbs / Carton: 24 pcs / 29.10 lbs

*Double laptop backpack - Compatible up to 16" laptop - Capacity: 15 L*

11.02 x 5.51 x 14.96" / G.W: 1.23 lbs / Carton: 24 pcs / 29.54 lbs

**LC2801 2 IN 1 DOCUMENT BAG**



14"



Porte-documents convertible en sac à dos - Compartiment pour ordinateur 14" - Poignées rétractables - Sangles dissimulables - Fermetures gomme étanche - Capacité : 5 L

38 x 5,5 x 26,5 cm / P. Brut: 475 g / Colisage: 24p / 11.4 kg

*Convertible briefcase into backpack - 14" laptop compartment - Retractable handles - Concealable handles - Waterproof rubber zippers Capacity: 5 L*

14.96 x 2.16 x 10.4" / G.W: 1.05 lbs / Carton: 24p / 25.13 lbs

**LC2802 DOCUMENT BAG**



15"

16"



Porte-documents et ordinateur - Compartiment pour ordinateur jusqu'à 16" - Bandoulière - Capacité : 17 L

41,5 x 9 x 31 cm / P. Brut: 420 g / Colisage: 24p / 10.6 kg

*Laptop document bag - Compatible up to 16" laptop - Shoulder strap - Capacity: 17 L*

16.34 x 3.54 x 12.20" / P. Brut: 0.93 lbs / Carton: 24p / 23.37 lbs

**LC2804 SLIM LAPTOP BAG**



13"

14"



Porte-documents et ordinateur - Compartiment pour ordinateur jusqu'à 14" - Capacité: 5 L

37 x 5 x 29 cm / P. Brut: 350 g / Colisage: 24p / 8.4 kg

*Laptop document bag - Compatible up to 14" laptop - Capacity: 5 L*

14.57 x 1.97 x 11.42" / G.W: 0.77 lbs / Carton: 24p / 18.52 lbs

**LC2805 DUFFLE BAG**



Sac de voyage - Base renforcée - Capacité: 30 L

45 x 23 x 30 cm / P. Brut: 550 g / Colisage: 12p / 6.6 kg

*Travel bag - reinforced base - Capacity: 30 L*

17.71 x 9.05 x 11.81 / G.W: 1.21 lbs / Carton: 12p / 14.55 lbs



**LN2700 A4 FOLDER**



Conférencier A4 - Bloc-notes 50 feuilles  
33 x 2 x 25 cm / P. Brut: 850 g / Colisage: 12p / 10.4 kg  
A4 blinder - 50 pages memo pad  
12.99 x 0.78 x 9.84" / G.W: 1.87 lbs / Carton: 12p / 22.92 lbs

**LN2702 MEDIUM LAPTOP BAG**



Porte-documents et ordinateur - Compartiment pour ordinateur jusqu'à 14" - Bandoulière large - 2 poignées en aluminium - Capacité: 6 L  
36 x 6.5 x 27.5 cm / P. Brut: 570 g / Colisage: 12p / 6.8 kg  
Laptop document bag - Compatible up to 14" laptop - Wide shoulder strap - 2 aluminium handles - Capacity: 6 L  
14.2 x 2.5 x 10.8" / G.W: 1.25 lbs / Carton: 12p / 14.99 lbs

**LN2701 SLIM LAPTOP BAG**



Porte-documents et ordinateur - Compartiment pour ordinateur jusqu'à 14" - Capacité: 5 L  
37 x 5 x 26 cm / P. Brut: 280 g / Colisage: 24p / 6.7 kg  
Laptop document bag - Compatible up to 14" laptop - Capacity: 5 L  
14.57 x 1.97 x 10.24" / G.W: 0.62 lbs / Carton: 24p / 14.77 lbs

**LN2703 LARGE LAPTOP BAG**



Porte-documents et ordinateur - Compartiment pour ordinateur jusqu'à 16" - Bandoulière large - 2 poignées en aluminium - Capacité: 10 L  
40 x 9 x 30.5 cm / P. Brut: 640 g / Colisage: 12p / 7.7 kg  
Laptop document bag - Compatible up to 16" laptop - Wide shoulder strap - 2 aluminium handles - Capacity: 10 L  
15.74 x 3.54 x 12.01" / G.W: 1.41 lbs / Carton: 12 p / 16.97 lbs

**LN2704 SLIM BACKPACK**



Sac à dos - Compartiment pour ordinateur jusqu'à 14" - Capacité: 16 L  
29 x 14 x 40 cm / P. Brut: 480 g / Colisage: 12p / 5.7 kg  
Backpack - Compatible up to 14" laptop - Capacity: 16 L  
11.42x5.51x15.75" / G.W:1.06lbs/Carton:12p/12.57lbs

**LN2705 DOUBLE BACKPACK**



Sac à dos double - Compartiment pour ordinateur jusqu'à 16" - Capacité: 17 L  
29 x 14.5 x 40 cm / P. Brut: 610 g / Colisage: 12 pcs / 7.3 kg  
Double laptop backpack - Compatible up to 16" laptop - Capacity: 17 L  
11.42 x 5.70 x 15.7" / 1.34 lbs / Carton: 12 pcs / 16.09 lbs

**LN2706 DUFFLE BAG**



Sac de voyage - Base renforcée - 2 poignées en aluminium - Capacité: 32 L  
45 x 23.5 x 30.5 cm / 670 g / Colisage: 12p / 8 kg  
Travel bag - reinforced base - Capacity: 32 L  
17.72 x 9.25 x 12.01" / 1.47 lbs / Carton: 12p / 17.64 lbs

**LN2707 TOILETRY BAG**



Trousse de toilette - Capacité: 3.5 L  
22.5 x 16.5 x 16 cm / P. Brut : 320 g / Colisage : 36p / 11.5 kg  
Toiletry bag - Capacity: 3.5 L  
8.9 x 6.5 x 6.3" / G.W: 0.7 lbs / Carton: 36 p / 25.3 lbs



**LN2406 15" DOCUMENT BAG**

**15"**



B N K G

Porte-documents et ordinateur - Compartiment pour ordinateur 15" - Bandoulière - Capacité: 11 L

40 x 10 x 29 cm / P. Brut : 560 g / Colisage : 20 p / 11.20 kg

Laptop document bag - 15" laptop compartment - Shoulder strap - Capacity: 11 L

5.7 x 3.9 x 11.4" / G.W: 1.23 lbs / Carton: 20 p / 24.69 lbs

**LN2404 DOCUMENT BACKPACK**

**15"**



B  
N  
K  
G

Porte-documents et sac à dos - Compartiment pour ordinateur 15" - Capacité: 12 L

29 x 10.5 x 42 cm / P. Brut: 860 g / Colisage: 8p / 6.9 kg

Document bag & Backpack - 15" laptop compartment - Capacité: 12 L

11.42 x 4.13 x 16.53" / G.W: 1.89 lbs / Carton: 8p / 15.21 lbs

**LN2405 ENVELOP BRIEF**

**15"**



B  
N  
K  
G

Porte-documents et ordinateur - Compartiment pour ordinateur 15"

40 x 4 x 28 cm | P. Brut: 420 g | Colisage: 20 p / 8.40 kg

Laptop document bag - 15" laptop compartment

15.7 x 1.6 x 11" | G.W: 0.92 lbs / Carton: 8 p / 18.51 lbs

**LN2400 A4 FOLDER**



B  
N  
K  
G

Conférencier A4 - Fermeture à glissière

24 x 2 x 33 cm / P. Brut: 470 g / Colisage: 20 p / 10.70 kg

A4 folder - Zipper closure

9.4 x 0.8 x 13" / G.W: 1.04 lbs / Carton: 20 p / 23.59 lbs

**LN2401 LAPTOP BRIEF**

**13"**

**14"**



Porte-documents et ordinateur - Compartiment pour ordinateur jusqu'à 14"

40 x 3 x 27 cm / P. Brut: 420 g / 20p / 8.40 kg

Laptop document bag - Compatible up to 14" laptop

15.74 x 1.18 x 10.63" / G.W: 0.92 lbs / Carton: 20 p / 18.52 lbs

**LN2402 SIMPLE BACKPACK**

**13"**

**14"**



B  
N  
K  
G



Sac à dos - Compartiment pour ordinateur jusqu'à 14" - Capacité: 18 L

28 x 16 x 40 cm / P. Brut: 590 g / Colisage: 8p / 4.7 kg

Backpack - Compatible up to 14" laptop - Capacity: 18 L

11.02 x 6.29 x 15.75" / G.W: 1.30 lbs / Carton: 8p / 10.36 lbs

**LN2403 DOUBLE BACKPACK**

**13"**

**14"**



B  
N  
K  
G



Sac à dos double - Compartiment pour ordinateur jusqu'à 14" - Capacité: 20 L

28 x 18 x 40 cm / P. Brut: 690 g / Colisage: 8p / 5.5 kg

Double backpack - Compatible up to 14" laptop - Capacity: 20 L

11.02 x 7.09 x 15.75" / G.W: 1.52 lbs / Carton: 8p / 12.12 lbs



# CHALLENGER

Design by Marco Pulga & Luca Artioli

# CHALLENGER

Design by Marco Pulga & Luca Artioli



N

B

BG

W

## LC654 BACKPACK



15"

16"



- N
- B
- BG
- W

Sac à dos double - Compartiments pour ordinateur jusqu'à 16" et tablettes - Dos renforcé - Poignée rétractable - Sangles dissimulables - Fermetures gomme étanche - Capacité : 20 L

30 x 17 x 40 cm / P. Brut : 890 g / Colisage : 6 p / 5.3 kg

Double backpack - Compatible up to 16" laptop & tablet compartments - Reinforced back - Retractable handle - Concealable handles Waterproof rubber zippers - Capacity: 20 L

11.8 x 6.7 x 15.7" | G.W: 1.96 lbs / Carton: 6 p / 11.68 lbs

## LC662 DOCUMENT BACKPACK



15"

16"



- N
- B
- BG
- W

Porte-documents convertible en sac à dos - Compartiments ordinateur 16" et tablettes - Poignées rétractables - Sangles dissimulables - Fermetures gomme étanche - Capacité : 12 L

30 x 10 x 41 cm / P.Brut: 900 g / Colisage: 12p / 10.8 kg

Convertible briefcase into backpack - 16" laptop & tablet compartments Retractable handles - Concealable handles Waterproof rubber zippers - Capacity: 12 L

11.8 x 3.9 x 16.1" | G.W: 2 lbs / Carton: 12 p / 23.8 lbs

## LC663 LAPTOP BRIEF



15"

16"

- N
- B
- BG
- W

Porte-documents extra plat pour ordinateur jusqu'à 16" - Fermetures gomme étanche

39 x 2 x 28 cm / P.Brut: 430 g / Colisage: 20p / 8.6 kg

Extra-slim document bag - Compatible up to 16" laptop - Waterproof rubber zippers

15.4 x 0.8 x 11" | G.W: 0.94 lbs / Carton: 20 p / 18.96 lbs

## LC664 13" LAPTOP BRIEF



13"

- N
- B
- BG
- W

Porte-documents extra plat pour ordinateur 13" - Fermetures gomme étanche

36.5 x 2 x 25 cm / P.Brut: 420 g / Colisage: 20p / 8.4 kg

Extra-slim 13" laptop document bag - Waterproof rubber zippers

14.37 x 0.78 x 9.84" / G.W: 0.92 lbs / Carton: 20 p / 18.51 lbs

## LC651 DOCUMENT BAG



13"

14"

- N
- B
- BG
- W

Porte documents et ordinateur - Compartiment pour ordinateur jusqu'à 14" - Poignées rétractables - Poches zippées en façade

40 x 30.5 x 6.5 cm / P. Brut : 590 g / Colisage : 18 p / 10.6 kg

Laptop document bag - Compatible up to 14" laptop - Retractable handles - Front zip pockets

15.7 x 11.8 x 2.5" / G.W: 1.3 lbs / Carton: 18 p / 23.37 lbs

## LC652 DOCUMENT BAG



15"

16"

- N
- B
- BG
- W

Porte documents et ordinateur - Compartiment ordinateur jusqu'à 16" - Poignées rétractables - Poches zippées en façade

40 x 30 x 9 cm / P.Brut: 820 g / Colisage: 12p / 10.8 kg

Laptop document bag - Compatible up to 16" laptop - Retractable handles - Front zip pockets

15.7 x 11.6 x 3.7" / G.W: 1.80 lbs / Carton: 12 p / 23.81 lbs

= Each bag saves the equivalent of the number of plastic bottles indicated

= Chaque sac permet d'économiser l'équivalent du nombre de bouteilles plastiques indiqué



# EVE

Design by Luca Artioli



# TERA

Design by Luca Artioli



## LC2200 EVE BACKPACK



Passant pour trolley  
Loop for trolley

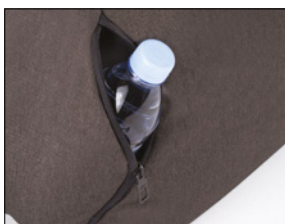

Poche isotherme  
Cooler pocket



Poche pour mobile  
Mobile phone pouch



Dos renforcé - Ouverture au dos  
Reinforced back - Backside opening

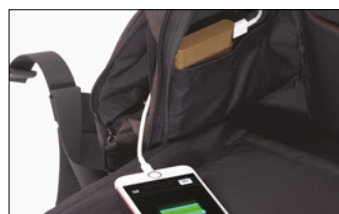

Poche Power bank avec œillet pour câble  
Power bank pouch with eyelet for USB cable

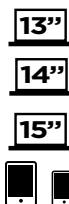

Sac à dos anti-ivol - Compartiments pour ordinateur jusqu'à 15" et tablettes - Ouverture au dos - Pochette pour power bank avec passage pour fil et prise USB - Capacité : 22 L

30 x 18.5 x 40 cm / P.Brut: 670 g / Colisage: 12p / 8 kg

Anti-theft backpack - Compatible up to 15" laptop and tablet compartments - Back side opening - Power bank pocket with wire space and USB plug - Capacity: 22 L

11.8 x 7.28 x 15.7" / G.W: 1.47 lbs / Carton: 12 p / 17.63 lbs



## LC2600 BACKPACK



Sac à dos - Poignée latérale - Compartiment pour ordinateur 15" - Dos renforcé - Multi poches - Capacité: 16 L

30 x 13 x 43 cm / P.Brut: 790 g / Colisage: 12p / 8.4 kg

Backpack - Side handle - 15" laptop compartments

- Reinforced back - Multi pockets - Capacity: 16 L

11.8 x 5.1 x 16.9" / G.W: 1.74 lbs / Carton: 12 p / 18.51 lbs

## LC2602 GYM BAG



Sac à dos double compartiments - Usage sport et business - Compartiments ordinateur 15" et tablettes - Dos renforcé - Multi poches - Capacité: 23 L

30 x 17 x 45 cm / P.Brut: 900 g / Colisage: 12p / 10.4 kg

Double compartment backpack - For sport and business - 15" laptop and tablet compartments - Reinforced back - Multi pockets - Capacity: 23 L

11.8 x 6.7 x 17.7" / G.W: 2 lbs / Carton: 12 p / 22.93 lbs

## LC2601 MESSENGER BAG



Sac messenger - Compartiment pour ordinateur 15" - Dos renforcé - Multi poches - Capacité: 19 L

40 x 18 x 27 cm / P.Brut: 700 g / Colisage: 12p / 7.4 kg

Messenger bag - 15" laptop compartment - Reinforced back - Multi pockets - Capacity: 19 L

15.7 x 7.08 x 10.6" / G.W: 1.54 lbs / Carton: 12 p / 16.31 lbs

## LC2603 ORGANIZER POUCH



Pochette renforcée pour accessoires électroniques - Ouverture à plat

25 x 7 x 14 cm / P.Brut: 130 g / Colisage: 48 p / 6.2 kg

Reinforced pouch for electronic accessories - Flat opening

9.9 x 2.8 x 5.5" / G.W: 0.29 lbs / Carton: 48 p / 13.67 lbs

= Each bag saves the equivalent of the number of plastic bottles indicated

= Chaque sac permet d'économiser l'équivalent du nombre de bouteilles plastiques indiqué

# PEANUT

Design by Luca Artioli



# PACKABLE

Design by Margherita Matticari & Luca Artioli



## LN1510 PEANUT BACKPACK



- X
- B
- K
- TR
- BG
- PR
- Y



B K TR



BG PR Y

Sac à dos repliable en pochette compacte - Capacité : 18 L

Sac à dos: 31 x 14 x 43cm / Plié en pochette: 14 x 2.5 x 24 cm / P. Brut : 260 g / Colisage : 48 p / 12.5 kg

*Foldable backpack in a pouch - Capacity: 18 L*

*Backpack: 12.2 x 5.5 x 16.9" / Foldable in pouch: 5.5 x 0.98 x 9.4" / G.W: 0.57 lbs / Carton: 48 p / 27.56 lbs*

## LN1513 PEANUT DUFFLE BAG



- X
- B
- K

Sac de voyage repliable en pochette compacte - Capacité : 54 L

Sac de voyage: 57.5 x 30 x 35 cm / Plié en pochette: 27 x 6 x 14cm / P.Brut: 430g / Colisage: 48p / 20.6 kg

*Travel bag foldable in a pouch - Capacity: 54 L*

*Duffle bag: 22.6 x 11.8 x 13.8" / Foldable in pouch: 10.62 x 2.36 x 5.51" / G.W: 0.95 lbs / Carton: 48 p / 45.41 lbs*

## LN1512 PEANUT GYM BAG



- X
- B
- K
- TR
- BG
- PR
- Y

Sac de gym repliable en pochette compacte - Capacité : 27 L

Sac de gym: 44 x 21 x 30 cm / Plié en pochette: 24 x 6 x 14 cm / P. Brut : 320 g / Colisage : 48 p / 15.3 kg

*Gym bag foldable in a pouch - Capacity: 27 L*

*Gym bag: 17.3 x 8.3 x 11.8" / Foldable in pouch: 9.44 x 2.36 x 5.51" / G.W: 0.76 lbs / Carton: 48 p / 33.73 lbs*



NC N B K BG

## LC2310 PACKABLE DUFFLE

Design by Margherita Matticari



- NC
- N
- B
- K
- BG

Sac de voyage cylindrique repliable en pochette compacte - Capacité : 21 L

Sac cylindrique: Ø 20.5 x 50 cm Plié en pochette: Ø 20.5 x 1.4 cm / P. Brut : 170 gr / Colisage : 48 p / 8.2 kg

*Foldable duffle bag - Capacity: 21 L*

*Duffle bag: Ø 8 x 19.6" / Foldable in pouch: Ø 8 x 0.5" / G.W: 0.37 lbs / Carton: 48 p / 18.07 lbs*



## LC2311 PACKABLE BACKPACK

Design by Luca Artioli



- NC
- N
- B
- K
- BG

Sac à dos repliable en pochette compacte - Capacité : 15 L

Sac à dos: 29 x 13 x 41 cm / Plié en pochette: 15 x 1.4 x 18.5 cm / P.Brut: 305 g / Colisage: 40p / 12.2 kg

*Foldable backpack - Capacity: 15 L*

*Backpack: 11.4 x 5.2 x 16.1" / Foldable in pouch: 5.9 x 0.5 x 7.2". G.W: 0.67 lbs / Carton: 40 p / 26.89 lbs*



Plié en pochette  
Foldable in pouch

## LL114 NEO LUGGAGE TAG

Design by Kazuya Koike



X7

A7

DB

R

Étiquette bagage avec lanière en gomme -  
Matériaux : aluminium / gomme. Marquage  
conseillé : sérigraphie - laser

Luggage tag with rubber string - Material:  
aluminium / rubber. Suggested branding:  
silkscreen - laser

3,3 x 0,7 x 8,8 cm | P.Brut: 45 g / Colisage :  
160p / 4,5kg

1.3 x 0.3 x 3.5" | G.W: 0.1 lbs | Carton: 100 p /  
9.92 lbs

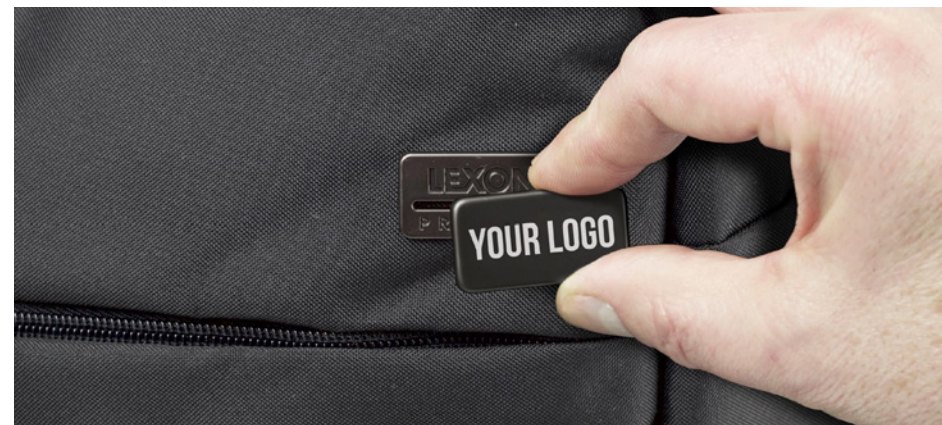

## CUSTOMIZE YOUR LEXON BAG

PERSONNALISEZ VOTRE SAC LEXON

Discover our range of over-plates\* customizable with your logo on  
request when placing your order.

Découvrez notre gamme de sur-plaques\* personnalisables avec votre logo  
sur demande à la commande.



\*Patented system / Système breveté

### ONE+



31mm x 19mm  
1.2 x 0.7"

### PREMIUM+



33 x 18 mm  
1,3 x 0,7"

### TRACK



32 mm x 13 mm  
1.2 x 0.5"

### CHALLENGER



60 mm x 9 mm  
2.4 x 0.4"

### EVE



Ø 37 mm  
Ø 1.4"

### TERA



40 x 31,5 mm  
1,6 x 1,2»

### PEANUT



44 mm x 34 mm  
1.7 x 1.3"

### PACKABLE



Ø 28 mm  
Ø 1.1"

Additional branding  
techniques  
available for bags:  
• Silkscreen on fabric  
• Digital printing

Autres techniques de  
marquage disponibles  
pour la bagagerie:  
• Sérigraphie sur tissu  
• Impression numérique

LEXON® × Keith Haring™



LEXON® × JEAN-MICHEL BASQUIAT™



Keith Haring™



**COLLABORATIONS** *COLLABORATIONS*

Drawing inspiration from Keith Haring's artistic style, characterized by bold lines, vibrant colors, and symbolic icons, Lexon has skillfully translated Haring's vision into tangible, everyday objects. This collaboration pays homage to Haring's belief that art should be accessible to all, bringing his iconic imagery into the realm of practical, everyday use.

*S'inspirant du style artistique de Keith Haring, caractérisé par des lignes audacieuses, des couleurs vibrantes et des icônes symboliques, Lexon a habilement traduit la vision de l'artiste à travers ses objets tangibles du quotidien. Cette collaboration rend hommage à la conviction de Haring selon laquelle l'art doit être accessible à tous, amenant son imagerie emblématique dans le domaine de l'utilisation pratique et quotidienne.*



**LIMITED-RUN PRODUCTION GIFT SETS** *COFFRETS EN SÉRIE LIMITÉE*

Limited in production, this exclusive gift set includes all four Lexon products capturing the essence of Keith Haring's masterpieces.

*Produit en série limitée, ce coffret cadeau exclusif comprend les quatre produits Lexon capturant l'essence des chefs-d'oeuvre de Keith Haring.*

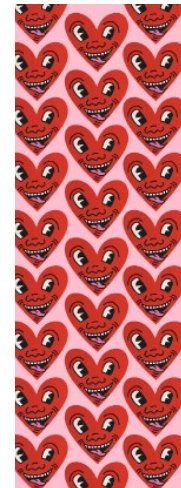

# JEAN-MICHEL BASQUIAT™



## COLLABORATIONS COLLABORATIONS

Pursuing our commitment to blend design and tech, we have reimagined our most popular objects to feature some of Jean-Michel Basquiat's iconic works. This exclusive collaboration embraces Lexon's inherently forward-thinking nature, seamlessly merging it with the artist's bold and exuberant style. The result is an inspiring fusion that celebrates art and creativity in everyday life, forging an harmonious symphony that unites form and function in an extraordinary manner.

*Poursuivant notre engagement à allier design et technologie, nous avons réinventé nos objets les plus populaires pour présenter certaines des oeuvres emblématiques de Jean-Michel Basquiat.*

*Cette collaboration exclusive embrasse la nature intrinsèquement avant-gardiste de Lexon, la fusionnant de manière transparente avec le style audacieux et exubérant de l'artiste. Le résultat est une fusion inspirante qui célèbre l'art et la créativité au quotidien, forgeant une symphonie harmonieuse qui unit forme et fonction d'une manière extraordinaire.*



## LIMITED-RUN PRODUCTION GIFT SETS COFFRETS EN SÉRIE LIMITÉE

Limited in production, this exclusive gift set includes all four Lexon products capturing the essence of Jean-Michel Basquiat's masterpieces.

*Produit en série limitée, ce coffret cadeau exclusif comprend les quatre produits Lexon capturant l'essence des chefs-d'oeuvre de Jean-Michel Basquiat.*



LBBSQ01-AN



LBBSQ01-C



LBBSQ01-D



LBBSQ01-B



LA125BSQ-AN

LA125BSQ-AR

LA125BSQ-AP

LA125BSQ-ABG

LA125BSQ-AB

LA125BSQ-AY



LR150BSQ-AN

LR150BSQ-AR

LR150BSQ-AP

LR150BSQ-ABG

LR150BSQ-AB

LR150BSQ-AY



LH64BSQ-AN

LH64BSQ-AR

LH64BSQ-AP

LH64BSQ-ABG

LH64BSQ-AB

LH64BSQ-AY



LA119BSQ-AN

LA119BSQ-AR

LA119BSQ-AP

LA119BSQ-ABG

LA119BSQ-AB

LA119BSQ-AY



LA125BSQ-C

LR150BSQ-C

LH64BSQ-C

LA119BSQ-C



LA125BSQ-D

LR150BSQ-D

LH64BSQ-D

LA119BSQ-D



LA125BSQ-B

LR150BSQ-B

LH64BSQ-B

LA119BSQ-B

**MATERIALS**  
MATÉRIAUX



# ANODIZED ALUMINUM

## LA125 MINO+



## LA129 MINO+ L

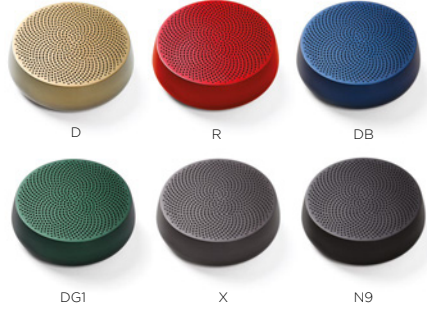

## LA131 TAMO

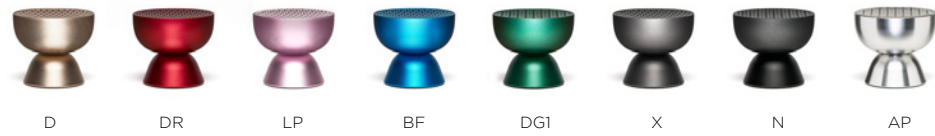

## LL134 WINO



## LH89 ROMINO



## LD149 MUSO



## LR154 MINUT



## LR152 FLIP PREMIUM



## LR155 RAY CLOCK



## LA132 RAY SPEAKER



## LH101 RAY LIGHT



## LR156 CONIC CLOCK



## LH100 CONIC LAMP



## LA133 CONIC SPEAKER



### LH60 MINA



### LH64 MINA M



### LH65 MINA L



### LH76 MINA L AUDIO



### LR153 MINA SUNRISE



### LH96 LUMA S



### LH87 LUMA M



### LH97 LUMA L



### LH98 LUMA XL



LH99 MIMI



LH95 STELI



LH70 BUBBLE LAMP

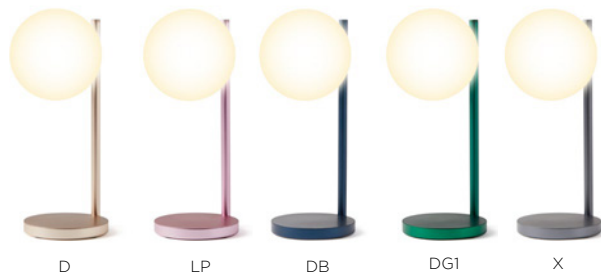

LH102 HELIA

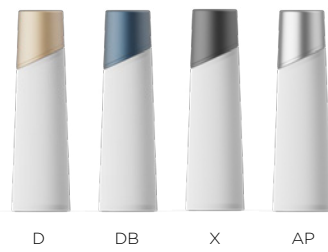

LA134 TERRACE+



LH103 BIRDY



LL158 METALI-C



LL160 TECLA



LS64 SCRIBALU



LL129 FINE BAG LIGHT 2

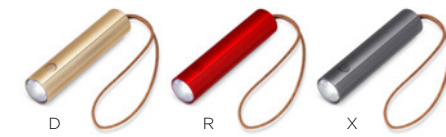

LL130 FINE TUBE POWER BANK 2



LD135 CITY RULER

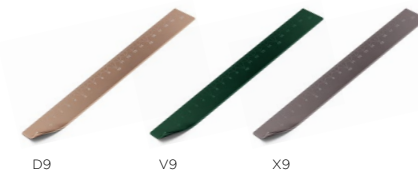

LD138 CITY DESK TRAY

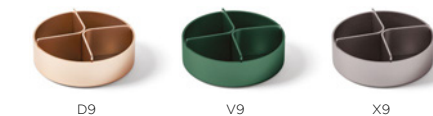

LD137 CITY CARD STAND



LD14 CARD BOX

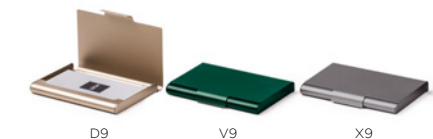

LD139 CITY TAPE DISPENSER



LD140 CITY PEN CUP

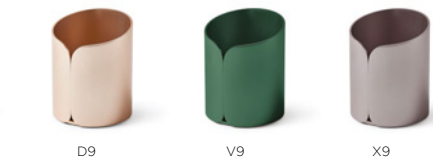

LL147 NOMADAY UV STRAW



LL156 NOMADAY PICNIC SET



LL157 NOMADAY PILLBOX



LD144 NOMADAY CARD

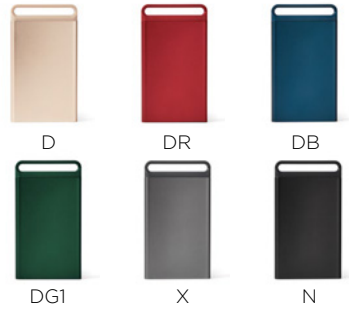

LH77 HORIZON HANGING LAMP



LH78 HORIZON SAFETOUCH

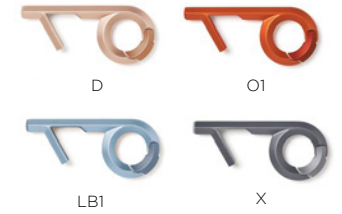

LH83 NOMADAY UV DRINK



LL148 HORIZON THERMO BOTTLE



LL138 NOMADAY POWER BANK



LL137 NOMADAY FLASH



LH85 HORIZON DIFFUSER



LH91 HORIZON DISPENSER



LL136 NOMADAY LIGHT



LL128 NOMADAY LOCK



LH84 HORIZON MAGSPRAY



# COLORS

## LR157 FLIP CLASSIC



## LR158 FLIP MINI



## LA123 MINO S



## LA124 MINO T



## LA120 MINO X



## LA119 TYKHO 3



## LD150 PEAS HUB C

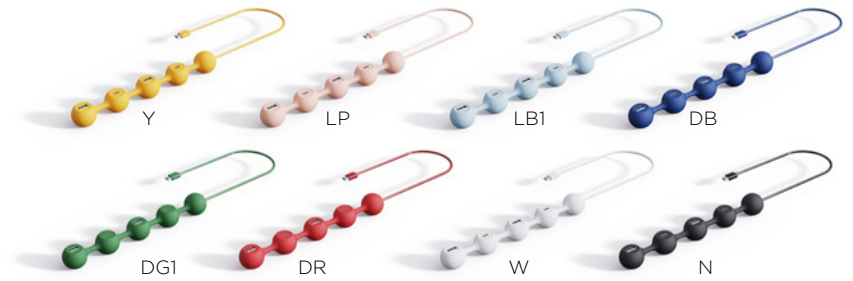

## LL161 PEAS POWER



## LU21 MINI HOOK UMBRELLA



# CLASSIC / BASIC COLORS

LH63 **BOLLA+**



LL121 **LUCIE**



LH88 **ORBE**



LH79 **MANO**



LH90 **DIVA**



LH59 **OBLIO**



LH69 **OBLIO BOX**



LH68 **OBLIO DUO**



LH104 **ARIA**



## GLOSSY

LA125 **MINO+**



LA124 **MINO T**



LS101 **C-PEN**



LH60 **MINA**



LH64 **MINA M**



LH65 **MINA L**



LS102 **C-PEN STYLUS**



# SYNTHETIC LEATHER

LA127 **SPEAKERBUDS**



LL153 **SOFTPOWER MAGBANK**



LL142 **SOFTPOWER WIRELESSBANK**



LA128 **POWERSOUND**

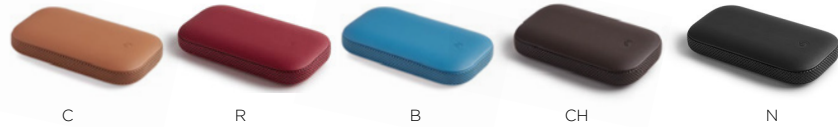

LL141 **OSLO ENERGY+**



LL152 **POWERON**



LD151 **POWERUP**



LA130 **OSLO NEWS PREMIUM**



LD145 **CITY ENERGY PRO**



LL148 **CITY LIGHT PRO**

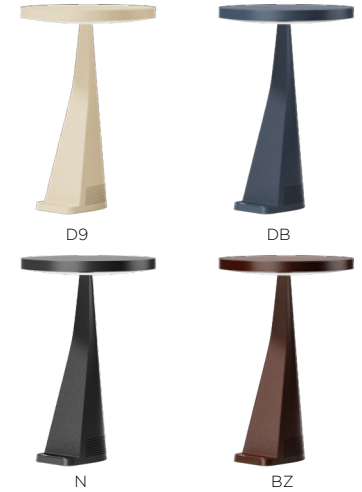

LH94 **LANTERN**



# WOOD

LH39 **ZEN CUP**



LH40 **ZEN LARGE CUP**



LH42 **ZEN COTTON BOX**



LH43 **ZEN TISSUE BOX**



# SALES & MERCHANDISING TOOLS

## SUPPORTS D'AIDE À LA VENTE

With our range of displays, enhance the presentation of our Lexon products in your store.  
We offer solutions tailored to the size and style of your retail space.

*Avec notre gamme de displays, sublimes la présentation de nos produits Lexon dans votre magasin.  
Nous proposons des solutions adaptées à la taille et au style de votre espace de vente.*

### ACRYLIC DISPLAYS PRÉSENTOIRS EN ACRYLIQUE



**LAD105**  
6 x MINO+

**LAD106**  
12 x MINO+



**LAD111**  
MINO+ / TWIN MINO+  
MINO X / MINO L / MINO T



**LAD107**  
MINO T



**LAD108**  
4 x MINO X



**LAD112**  
MINO+ / MINA M



**LAD77**  
4 x MINA



**LAD78**  
8 x MINA



**LAD39B**  
3 x TYKHO 3



**LAD48**  
6 x FLIP CLASSIC



**LAD64**  
6 x FLIP MINI



**LAD31B**  
DISPLAY FOR BAGS



**LAD76**  
LEXON BLOCK MARK



**LAD129 TO LAD146**  
PRODUCT BLOCK MARK

### CARDBOARD DISPLAYS CHEVALETS EN CARTON



297 x 210 mm

**LAD88**  
MINA



297 x 210 mm

**LAD94**  
MINO X



297 x 210 mm

**LAD99**  
TYKHO 3

### COUNTER DISPLAYS\* PLV DE COMPTOIR\*



495 x 300 x 300 mm

### WOODEN FURNITURE\* MOBILIER EN BOIS\*

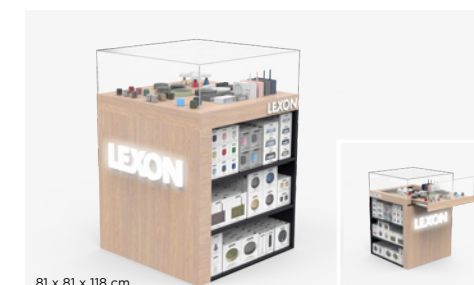

81 x 81 x 118 cm

\*on order only / sur commande uniquement

# CORPORATE GIFTS

## CADEAUX D'AFFAIRE

We design, develop and manufacture corporate gift objects to serve the needs of leading companies and brands.

*Nous concevons, développons et fabriquons des cadeaux d'affaire pour répondre aux besoins des grandes entreprises et des marques.*



**EQUIP YOUR TEAM**  
ÉQUIPEZ VOS COLLABORATEURS



**PROMOTE YOUR BUSINESS**  
FAITES LA PROMOTION DE VOTRE ENTREPRISE



**REWARD YOUR STAFF**  
RÉCOMPENSEZ VOTRE ÉQUIPE

### BRANDING TECHNIQUES

TECHNIQUES DE PERSONNALISATION



**SILKSCREEN**  
SÉRIGRAPHIE



**LASER**  
LASER

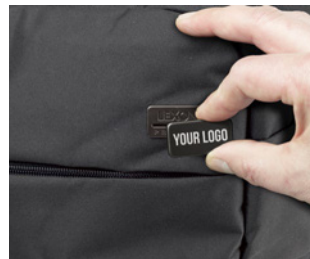

**LASER ON PLATE**  
LASER SUR PLAQUE



**GEL INK**  
ENCRE GEL



**PAD INK**  
TAMPOGRAPHIE



**DIGITAL PRINTING**  
IMPRESSION DIGITALE

### YOUR PROJECT

#### VOTRE PROJET

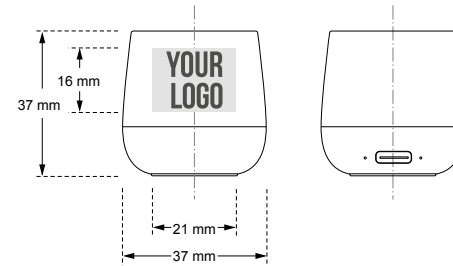

**BRANDING ON PRODUCT\***  
PERSONNALISATION DU PRODUIT\*



**BRANDING ON PACKAGING\*\***  
PERSONNALISATION DU PACKAGING\*\*

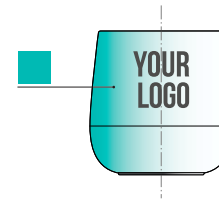

**SPECIAL COLOR DEVELOPMENT\*\*\***

DÉVELOPPEMENT D'UNE COULEUR PERSONNALISÉE\*\*\*

\*50 pcs / \*\*3000 pcs / \*\*\*5000 pcs



**SPECIAL KIT CREATION**

CRÉATION DE KIT THÉMATIQUE

### THEY TRUST US

#### ILS NOUS FONT CONFIANCE

SAINT LAURENT PARIS

KIENZO

AIRBUS

AUDEMARS PIGUET  
Le Brassus

ZARA HOME



PHILIP MORRIS INTERNATIONAL



Emirates

UBS

carhartt

Hertz

T-Mobile

intel.

# LEXON®

## DESIGN OBJECTS

Since its creation in 1991, Lexon has relentlessly pushed the limits and created a difference in the world of design while remaining true to its commitment to make small objects useful, beautiful, innovative and affordable. Whether in electronics, audio, office, leisure and travel accessories, Lexon has established a special relationship with creativity and partnered with the best designers around the world to create timeless collections of lifestyle products. Today, with more than 30 years of existence, more than 200 awards, collaboration with some of the most renowned designers, a retail presence in more than 90 countries across the Globe, Lexon has truly established itself as a worldly-known French design brand.



# BOW GROUP

BOW Group with its **4 offices around the world** - Paris, Geneva, Miami and Shenzhen - is a **global player and multi-skilled platform** with design, development, manufacturing and distribution capabilities, which offers solutions answering the needs of our modern lifestyles. With more than 2 million pieces sold every year, BOW aims to become **a world leader in lifestyle products and accessories in all their forms**: connected, design, art; with its **two consumers brands Lexon and MyKronoz**, its **two retail concepts** that are **Legacy** and **Musart**, as well as **BOW Industries**, its **R&D center** that owns 70 design patents.

## MYKRONOZ

CONNECTED OBJECTS

Founded in 2013, MyKronoz focuses on consumer IoT with a wide portfolio spanning from wearables, mainly with activity trackers and hybrid watches, as well as smart products for the home. To date, our Swiss brand has sold 3M of connected devices with its own cloud architecture and proprietary mobile app. Over the past three years, MyKronoz has won 3 Red Dot Design Awards and 2 iF Design Awards, proving its expertise in designing smart objects and meaningful experiences that enhance people's lives.

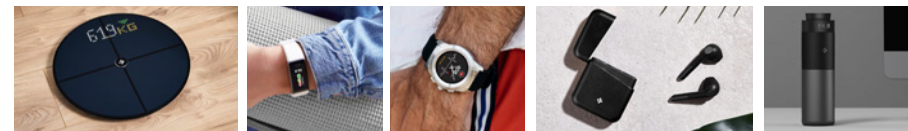

[mykronoz.com](http://mykronoz.com)

## MUSART

ART OBJECTS

Musart is a fast-growing art marketplace to buy original artworks and licensed products. Since its inception in 2014, the mission of this online destination is to make art accessible, giving anyone the opportunity to own a piece of museum. Partnerships with world-class institutions and cultural organizations allow Musart to bring not only exclusive and authentic items, but also, to honor iconic artists.

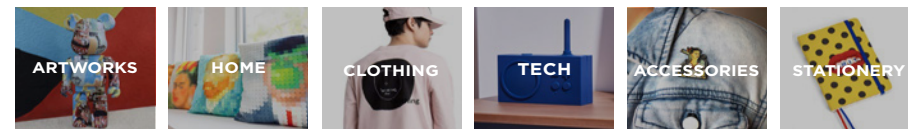

[musart.com](http://musart.com)

## LEGACY

LUXURY OBJECTS

Legacy is an exclusive hybrid concept store boasting a sharply curated selection of products comprising multiple categories such as watches, jewelry, art, tech, books, eyewear, beauty and more. We work both with well-established brands and young emerging talents to offer a unique selection of exceptional items and creations.

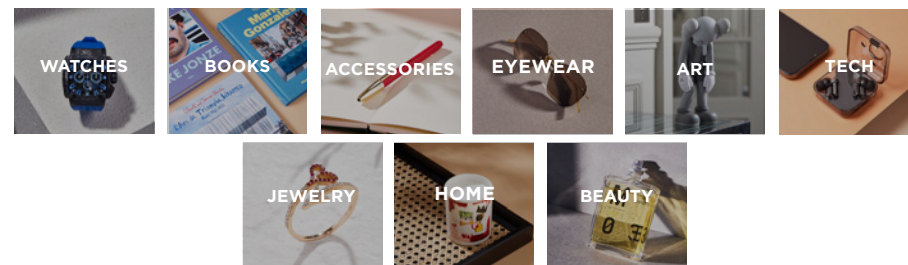

[store-legacy.com](http://store-legacy.com)

# LEXON®



LEXON - 125 Avenue des Champs-Élysées 75008 Paris France

[lexon-design.com](http://lexon-design.com) | [@lexondesign](https://www.instagram.com/lexondesign)